



For Android™ 11

# Enterprise Mobility

# PM560

# User Manual

# Instruction

This manual provides information about basic features and using the PM560. Please read this manual carefully before using your useful handheld terminal.



**Note:** Screenshots in this manual may differ from actual screens.

## Revision History

Revision	Date	Description
V1.0	24 Oct 2022	Initial release
V2.0	09 Mar 2023	Added BLE Beacon chapter, updated SKU information
V3.0	27 Mar 2023	Updated Battery safety information chapter
V4.0	24 Apr 2023	Added Enterprise Hot Swap chapter, charging temperature chapter Updated SKU information, Program buttons description
V5.0	27 Oct 2023	Added Numeric Keypad-related description Updated SKU information

## PM560 SKUs

The contents of this manual can cover the following SKUs.

SKU	Part Number	Scanner	Keypad	RAM /Flash	Wireless	Etc.
SKU1	P560X3YA3DJE05	N6703	Alpha-Numeric	4G/64G	WiFi, Bluetooth v5.1, BLE Beacon	NFC Android 11 (GMS)
SKU2	P560X3WA3DJE05	SE4750SR-IM				
SKU3	P560X38A3DJE05	N6803FR				
SKU5	P560X3W33DJE05	SE4750SR-IM	Numeric			

# Table of Contents

---

<b>INSTRUCTION .....</b>	<b>1</b>
Revision History .....	1
PM560 SKUs .....	1
<b>GETTING STARTED .....</b>	<b>6</b>
Device Parts .....	6
Product Standard Accessories.....	8
Install & Remove Battery .....	9
Install the battery .....	9
Remove the battery .....	9
Battery hot swap .....	10
Charge the Device .....	11
Battery specification .....	11
Charging temperature.....	11
Charge with power adapter.....	12
Charging Cradle .....	13
LED Indicator .....	14
Turn On / Off the Device .....	15
Use a Touch Screen .....	16
Controlling the touch screen .....	16
System navigation .....	18
<b>LEARNING THE BASICS.....</b>	<b>20</b>
Setup Wizard .....	20
Home Screen.....	21
Status bar .....	22
Notification panel .....	23
Quick setting panel .....	24

# Table of Contents

---

Apps & Widget.....	25
MTP Connection with PC.....	29
Manage the Files.....	30
Lock the Screen.....	32
Settings.....	33
Adjust display brightness.....	33
Adjust sound.....	33
Use Keyboard Backlight.....	34
Adjust font size.....	34
<b>USING THE KEYPAD.....</b>	<b>35</b>
Alpha-Numeric Keypad.....	35
Numeric Keypad.....	38
Use the Buttons.....	41
Functions.....	41
Screenshot.....	41
Program buttons.....	42
<b>SCANNER.....</b>	<b>43</b>
Turn on / off the Scanner.....	43
ScanSettings.....	44
Basic.....	44
Options.....	45
Notification.....	46
Wedge.....	47
Symbologies.....	52
About.....	52
Scan a Barcode.....	53
N6703 Scanner SKU (SKU1).....	53

# Table of Contents

---

SE4750 Scanner SKU (SKU2) .....	53
N6803FR Scanner SKU (SKU3) .....	54
ScanDemo .....	54
<b>WIRELESS .....</b>	<b>55</b>
Wi-Fi .....	55
Bluetooth.....	56
Turn on / off .....	56
Pair and Connect.....	56
Unpair and Disconnect .....	57
Change the Bluetooth device details .....	58
BLE Beacon.....	58
NFC .....	59
<b>SYSTEM MAINTENANCE .....</b>	<b>60</b>
System Information .....	60
On Settings.....	60
On EmKit .....	60
Check Device Health .....	61
OS Update .....	62
OS update via storage .....	62
OS update via OTG port.....	63
OS update via FOTA .....	63
Factory Data Reset.....	65
Factory data reset via Settings app .....	65
Factory data reset via recovery mode .....	66
<b>ACCESSORIES.....</b>	<b>67</b>
Hand Strap.....	67
Mount hand strap.....	68

# Table of Contents

---

Single Slot Cradle (SSC / SEC) .....	69
4 Slot Cradle (4SC).....	70
6 Slot Battery Cradle (6SBC) .....	70
<b>SAFETY INFORMATION.....</b>	<b>71</b>
Battery Safety Information .....	71

# Getting Started

## Device Parts

Figure 1 PM560 front + left view

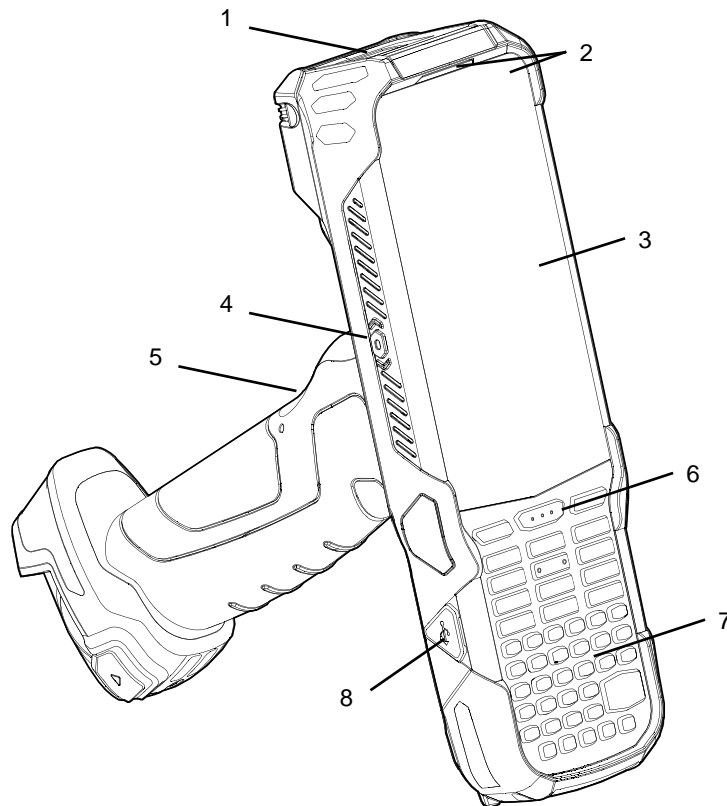

No	Name	Description
1	Scanner	Scans a barcode
2	Front LED indicators	Indicates the power status and notification Find more details in <a href="#">LED indicator</a>
3	Touch screen	Displays all operating screen
4	Power button	Turn on/off the device
5	Scan button (Gun handle)	Scan a barcode by pressing
6	Scan button (Front)	Scan a barcode by pressing (Only on Alpha-Numeric keypad)
7	Keypad	Alpha-Numeric or Numeric keypad (For more detail, refer to <a href="#">Using the Keypad</a> )
8	USB connector	USB 2.0 Type C

# Getting Started

Figure 2 PM560 rear + bottom view

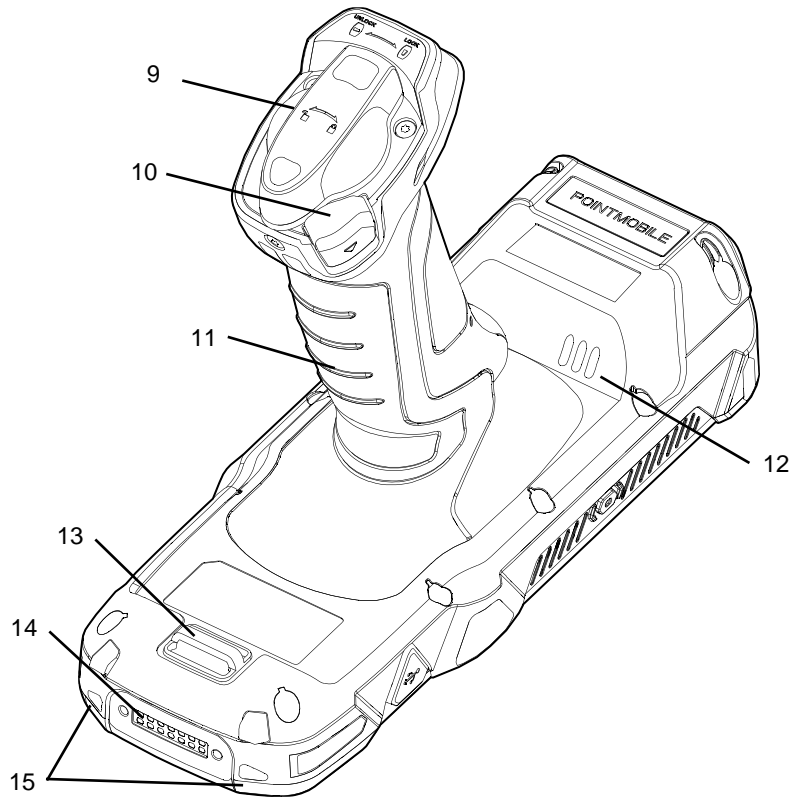







No	Name	Description
9	Battery	Provides power
10	Battery release button	Press to release the battery
11	Gun handle	Ergonomic handle for carrying PM560 and additional button
12	Speaker	Rings system sound
13	Hand strap hole	Mount hand strap
14	I/O connector	Connector for cradle communication
15	Bottom LED indicators	Indicates the system notification Find more details in <a href="#">LED indicator</a>



# Getting Started

## Product Standard Accessories

The following items are in the product box.

Accessory	Name
	Battery pack
	5V 2A power adapter
	AC plug
	USB type C cable
	Hand strap
	LCD protection film



**Note:** The images may differ from the actual accessory.

# Getting Started

## Install & Remove Battery

### Install the battery

1. Insert the battery into the gun handle with the battery end aligned horizontally.
2. Turn the battery clockwise until the battery release button is fully raised.

Figure 3 Install the battery

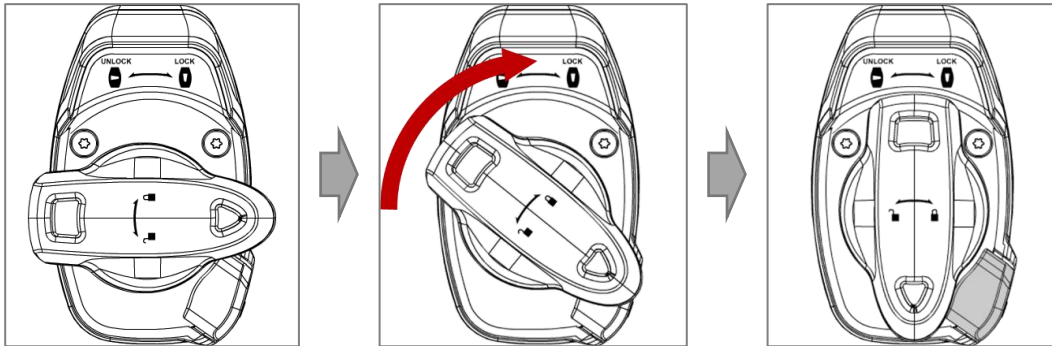

### Remove the battery

1. While pressing the battery release button, turn the battery counterclockwise.
2. Pull out the battery.

Figure 4 Remove the battery

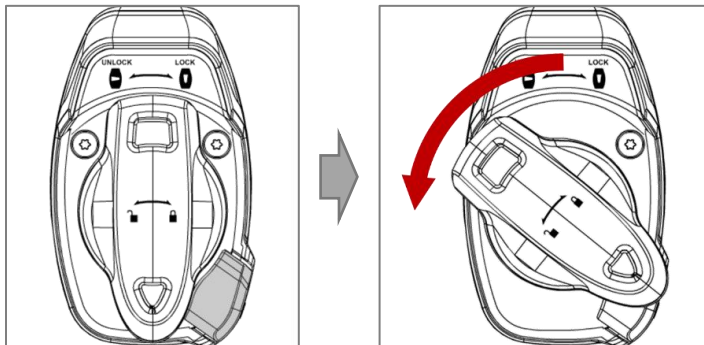

# Getting Started

---

## Battery hot swap

Battery hot swap is a feature that allows users to replace the battery without powering off. PM560 supports two types of hot swap mode, Enterprise hot swap, and Legacy hot swap. Basically, the device enters Enterprise hot swap mode. You can change the preferred hot swap mode in EmSettings.

## Enterprise hot swap

Enterprise hot swap allows the device to maintain Wi-Fi/Bluetooth connectivity and memory persistence even when detaching the battery. Users can earn time to replace the battery without stopping the ongoing task or disconnecting the Bluetooth devices.

But, as the backup battery with a smaller capacity than the main battery takes over to maintain the system, users are highly recommended to replace the battery within 30 seconds (30 seconds countdown displays). And some mitigations are activated to conserve power consumption.

- Reducing display brightness to about 10%
- Disabling NFC, Scanner
- Lowering sound volume

Once the user replaces the battery with a charged one, the device will come back to normal operation mode without booting process.



**Notice:** Do not change any settings or perform actions that may increase power consumption for device stability.

## Legacy hot swap

When the battery is removed from the device, the display turns off and the device waits for battery replacement.

Once the user replaces the battery with a charged one, the device will come back to normal operation mode without booting process.

# Getting Started

---

## Charge the Device

Before using PM560, charge the device enough to use. PM560 can be charged with power adapter or charging cradle. For best charging performance and safety, follow the normal [charging temperature](#).



**Caution:** Always use an original charger and cable from Point Mobile. Other chargers and cables may damage PM560. Also, make sure the charger and cables are not wet.

Follow the [Battery Safety Information](#) for safety of using the battery.

## Battery specification

- Capacity: 6,300mAh / 3.63V
- Rechargeable & Removable battery

## Charging temperature

**Charge devices and batteries in temperatures from 0 °C ~ 45 °C.** At out-of-normal range temperatures, the PM560 may stop charging for safety, and the power LED blinks red.

# Getting Started

---

## Charge with power adapter

1. Open the USB connector cap using the hole on the cap.

Figure 5 Open USB connector cap

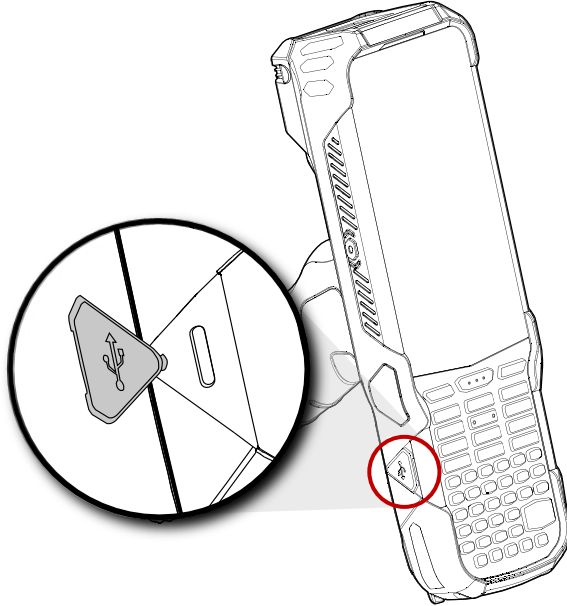

2. Assemble the country plug, power adapter and USB type C cable.
3. Connect the cable to the USB connector of PM560.
4. Provide power by plugging the power adapter to the wall socket.

Figure 6 PM560 charging with power adapter

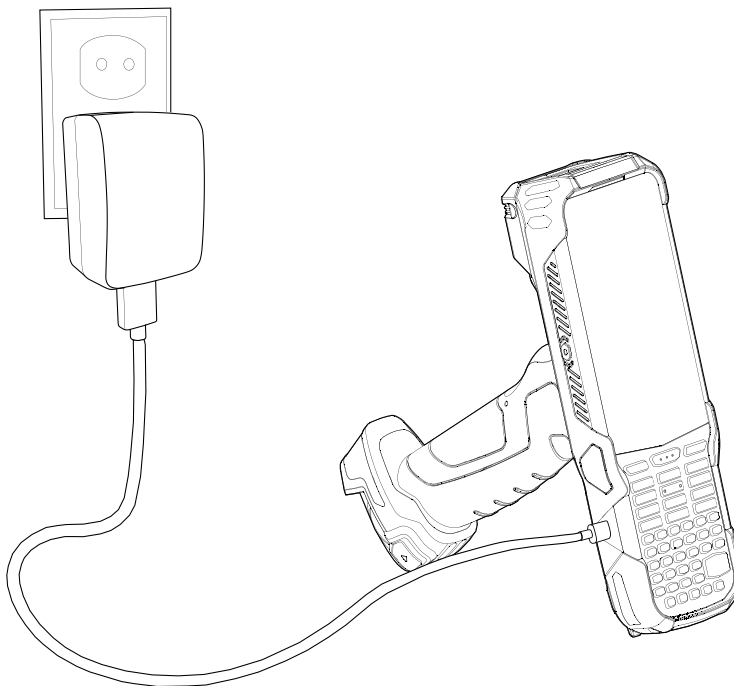

# Getting Started

## Charging Cradle

There are three types of charging cradle for PM560. Single slot (ethernet) cradle (SSC / SEC), 4 slot cradle (4SC), 6 slot battery cradle (6SBC). The cradles are sold separately.

When the PM560 is charging via charging cradle, the charging animation as below is displayed on the screen. (Refer to [Charge with Cradle](#) for more detail)

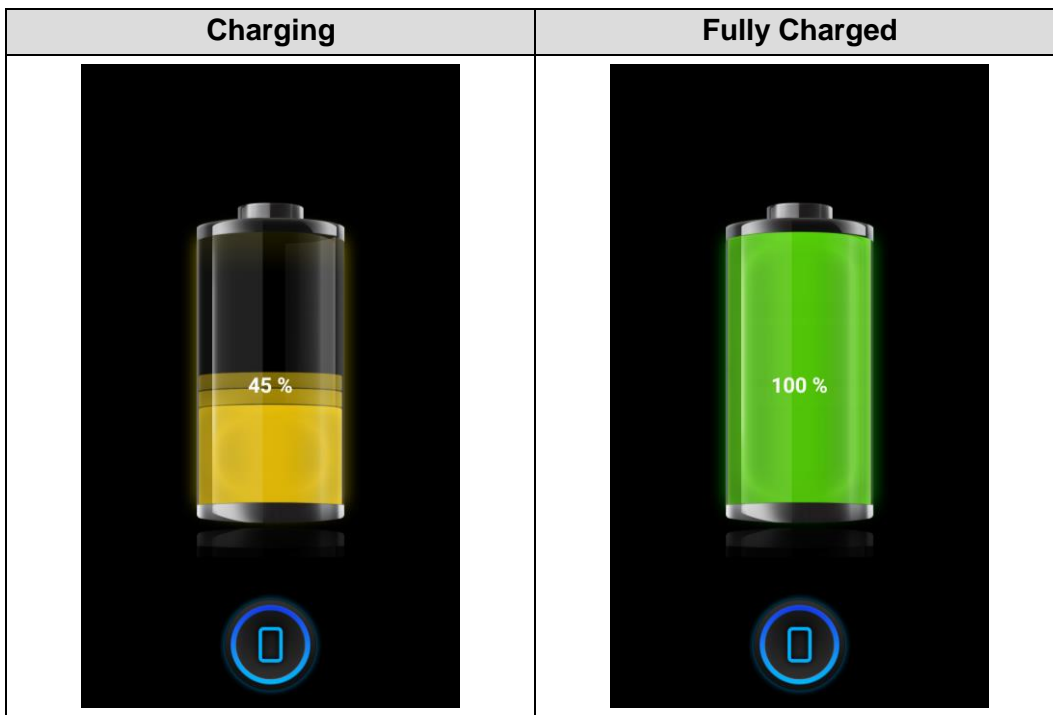

### Single Slot Cradle (SSC) / Single Slot Ethernet Cradle (SEC)

SSC and SEC provide one PM560 charging slot and one PM560 battery charging slot.

### 4 Slot Cradle (4SC)

4SC provides four PM560 charging slots.

### 6 Slot Battery Cradle (6SBC)

6SBC can charge up to 6 pieces of PM560 batteries at the same time.



**Note:** 4SC and 6SBC are compatible with PM550.







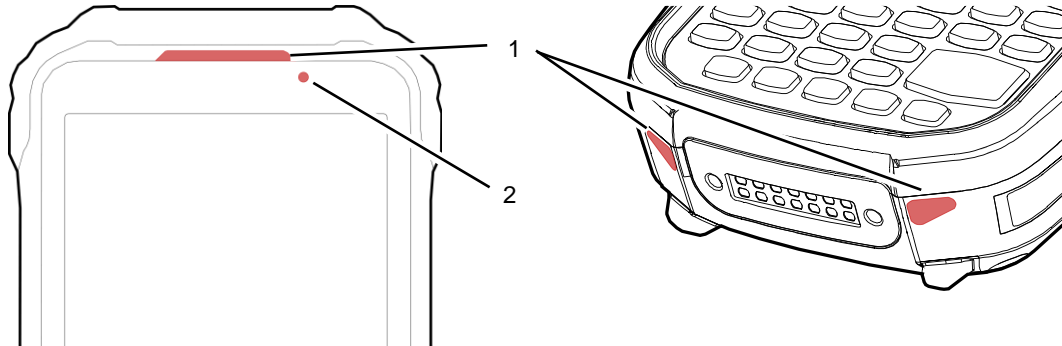

# Getting Started

## LED Indicator

PM560 has 3 LED indicators, two above the screen, and one at the bottom.

Figure 7 PM560 LED indicators



No	Indicator	Status	Indication
1	Notification LED (Top & Bottom)	 Solid red	Device entered Hot swap mode
		 Blinking blue	Notification existing
		 Red flash	Barcode reading failed
		 Blue flash	Barcode reading success
2	Power LED	 Solid green	Device is completely charged
		 Solid red	Device is charging / Battery is low
		 Blinking red	Charging temperature is out of normal range (Refer to <a href="#">Charging temperature</a> ) / Battery is very low
		 Alternately blinking red & green	Cannot recognize the battery

# Getting Started

---

## Turn On / Off the Device

To turn on the device,

- Press and hold the power button on the left side of the PM560 until **SMART BEYOND RUGGED** logo displays on the screen.

Figure 8 PM560 power button

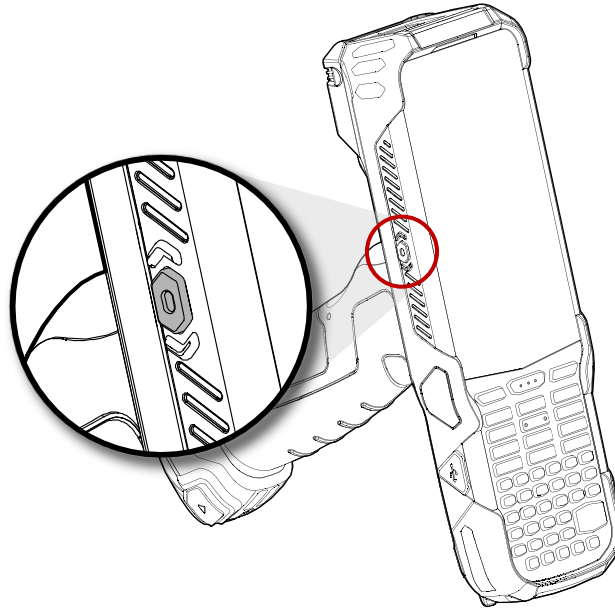

To turn off the device,

- Press and hold the power button when the display is on until the power menu is shown. Then, tap **Power off**.

Figure 9 Power menu - Power off







# Getting Started

---

## Use a Touch Screen

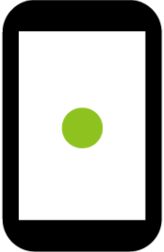
### Controlling the touch screen

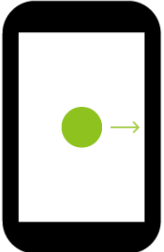
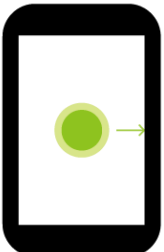
Gesture	Description
	<p><b>Tap</b> One-finger press</p>
	<p><b>Double tap</b> One-finger press, lift, one-finger press, lift for zoom in action</p>
	<p><b>Long-press</b> One-finger press, wait, lift for select action</p>
	<p><b>Drag, Swipe, or Fling</b> One-finger press, move, lift for scroll or tilt action</p>
	<p><b>Long-press drag</b> One-finger press, wait, move, lift for pick up and move, or select multiple items action</p>

# Getting Started

---

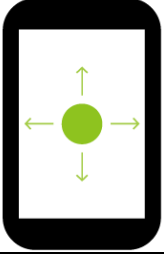
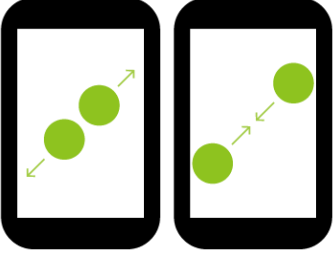
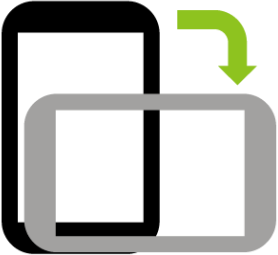
Action	Description
	<b>Scroll</b> Vertical or horizontal swipe in a single direction
	<b>Pinch Open &amp; Close</b> Two-finger press, move outwards and inwards, lift for <b>zoom in / out</b> action
	<b>Rotate</b> When PM560 is turning sideways, <b>screen orientation is changing</b>

# Getting Started

---

## System navigation

### Navigation bar (Software button)

The navigation bar is enabled as a default, and it is located at the bottom of the screen. The app overview button, home button, and back button are placed on the bar in order.

Figure 10 Navigation bar

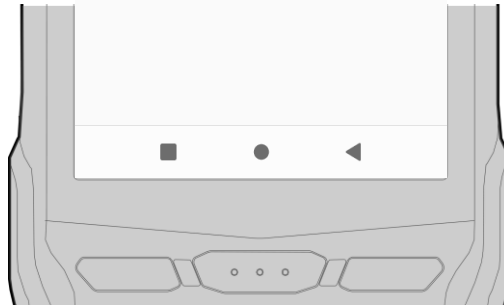



Shape	Button	Function
■	Recent apps button	Tap to see the recently used app list.
●	Home button	Tap to go to home screen. Long-press to launch the Google Assistant.
◀	Back button	Tap to go back to previous screen.

# Getting Started

## Gesture Navigation

If you are unfamiliar with the navigation bar or you want to see the screen with a wider screen, hide the navigation bar. The functions provided by the software buttons on the navigation bar can be used by using specific gestures.

To hide the navigation bar, navigate to **Setting**  > **System**  > **Gesture** > **System navigation** and change the setting to **Gesture navigation**. Then, the navigation bar will be hidden.



**Note:** To use the navigation bar again, change the setting to **3-button navigation**.

Figure 11 Gesture navigation

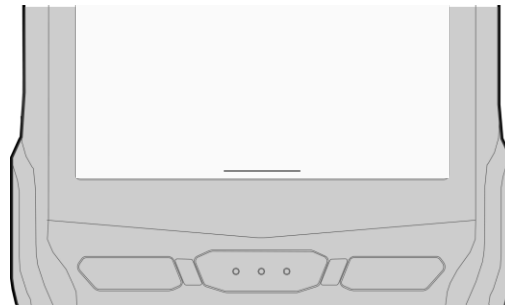

Find the gestures and matched function in the table below.

Function	Gesture
Open recent apps screen	Swipe up from the bottom of the screen, hold, then release.
Go to home screen	Swipe up from the center-bottom of the screen.
Back to previous screen	Swipe from the left or right edge of the screen.
Launch Google Assistant	Swipe up from either the left-bottom or right-bottom.

# Learning the Basics

---

## Setup Wizard

When PM560 starts very first time or boot after factory reset, Setup Wizard is launched. Following the steps on the screen, set system language, Google account, Wi-Fi connection and copy the data, etc.

Some settings can be skipped, but there may be some restrictions on the use of the system.

Figure 12 Setup Wizard (main)

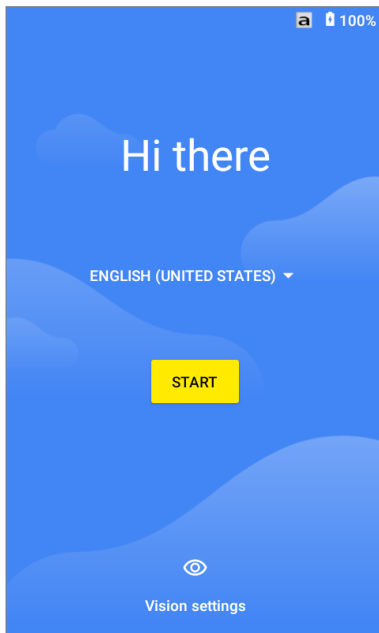
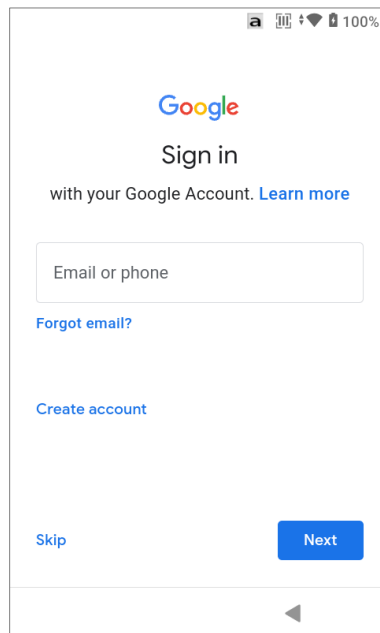

Figure 13 Setup Wizard (Google account)



# Learning the Basics

## Home Screen

Home screen is a screen displayed after Setup Wizard or pressing the Home button.

Figure 14 Home screen

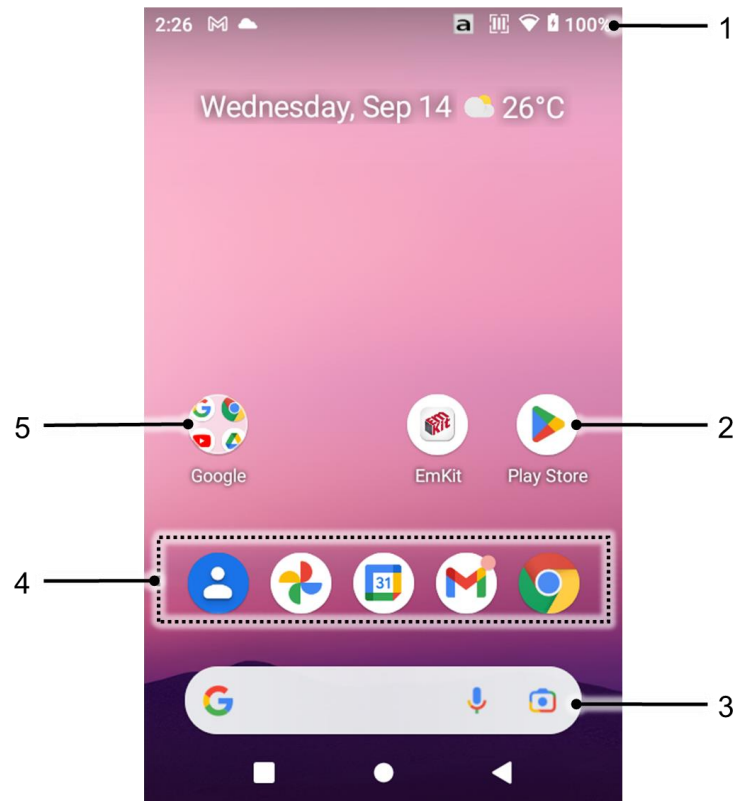



















No	Item	Description
1	Status bar	Indicates device status and notification.
2	App	Tap to run the application Long-press to see the application's options
3	Google search	Search an item with Google
4	Favorites tray	Place the frequently used apps
5	App folder	Apps are organized in the folder. Tap to open the App folder

# Learning the Basics









## Status bar

Time, status icons, and notification icons are on the Status bar.

### Status icons

Icon	Description	Icon	Description
	Airplane mode		Connected to a Bluetooth device
	Connected to a Wi-Fi network		Wi-Fi data communication
	Battery is full		Battery is low
	Battery is critical low		Cannot recognize battery
	Battery is charging		Alarm is set
	Location service turned on		Vibrate mode
	Scanner turned on		Scanner turned on, but trigger turned off
	Numeric input mode (Only for Numeric keypad)		Orange function input mode (Only for Alpha-Numeric keypad)
	Lowercase alphabet input mode		Uppercase alphabet input mode
	Blue function input mode		

### Notification icons

Icon	Description	Icon	Description
	New Email		Connected to VPN network
	Upcoming event		Other input method available
	File uploaded		File downloaded
	File copied		OTG device connected
	There are more notifications		

# Learning the Basics

---

## Notification panel

Notification panel displays a list of all notifications. Tap a notification to respond.

To open the Notification panel, drag the Status bar down. To close the panel, swipe it up.

Figure 15 Notification panel

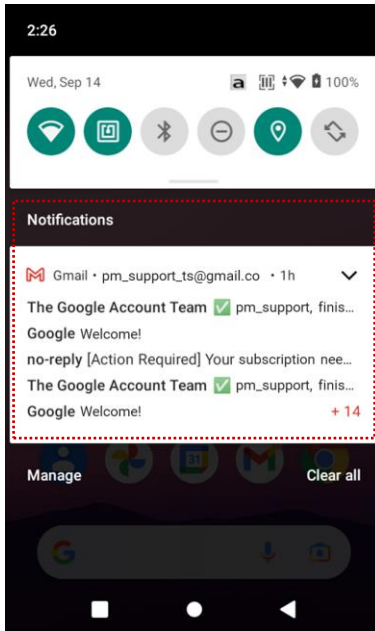



# Learning the Basics

---

## Quick setting panel

Quick setting panel contains some frequently used settings such as Wi-Fi, Bluetooth, etc.

To use the Quick setting panel,

1. Open the Notification panel.
2. Drag down the Notification panel.
3. Tap a setting icon to enable / disable the setting or long-press an icon to see more detail.

Figure 16 Quick setting panel

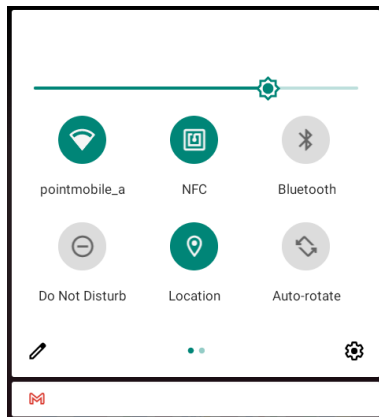

To edit the configuration of Quick setting panel,

1. Tap  on the bottom of the panel.
2. By long-press and dragging the icon, customize the configuration of the panel.

# Learning the Basics

---

## Apps & Widget

### App folder

To create the app folder, long-press an app icon and drag it to another app icon.

Figure 17 Create app folder

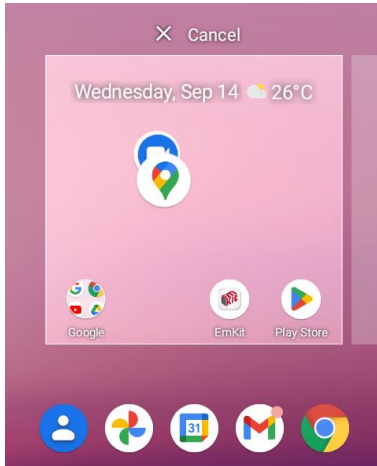

To change the folder name, tap the **Edit Name** and input a new name.

Figure 18 Change app folder name

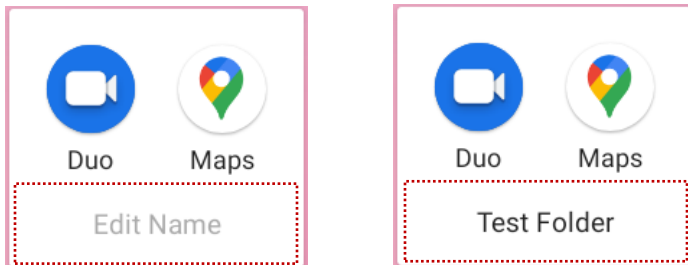

# Learning the Basics

---

## App drawer

All installed apps are listed alphabetically in App drawer.

- To open the App drawer, swipe up the Home screen.
- To close the App drawer, swipe down the Home screen.

Figure 19 App drawer

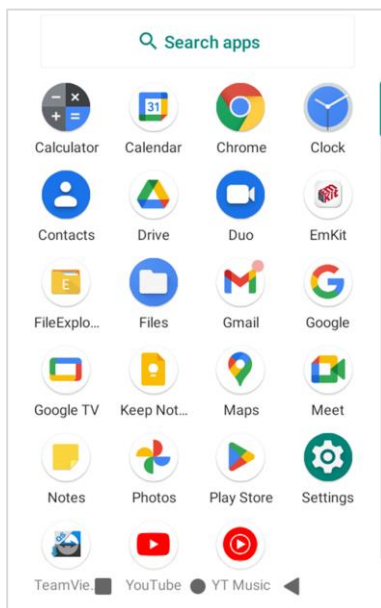

## Favorites tray

To organize an app in the Favorites tray,

1. Long-press an app icon from the App drawer. Then, drag it slightly until the Home screen is shown.
2. Place the app icon in the Favorites tray.

Figure 20 Add an app to Favorites tray



# Learning the Basics

---

## Organize app in Home screen

To organize an app in the Home screen,

1. Long-press an app icon from the App drawer. Then, drag it slightly until the Home screen is shown.
2. Place the app icon where you want.

(To cancel to place the app, drag it to **Cancel** area and release.)

Figure 21 Place app in Home screen

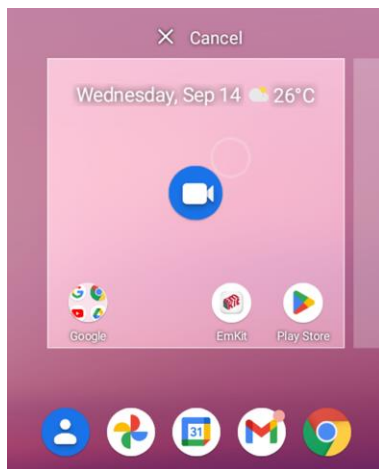

To remove an app or widget in the Home screen,

1. Long-press an app icon or widget.
2. Drag it to **Remove** area and release.

Figure 22 Remove from Home screen

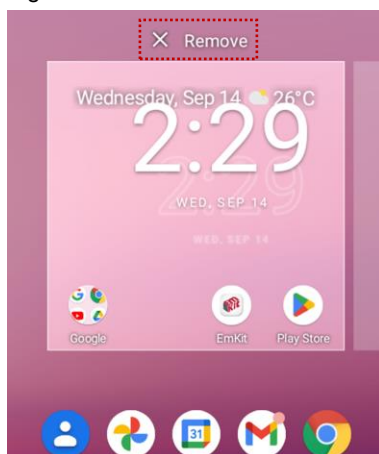

# Learning the Basics

---

## Widget

To add a widget in the Home screen,

1. Long-press the empty space of the Home screen.
2. In three menus, select **Widgets**.

Figure 23 Widget menus

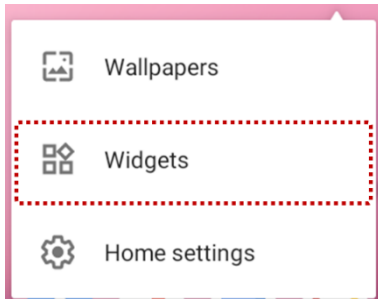

3. Among the list, tap and hold a widget you want to add.
4. Place the widget to the Home screen by dragging.

# Learning the Basics

## MTP Connection with PC

To transfer the files with a PC, connect the device to the PC via USB cable first.

1. Drag down Status bar and tap **Android System** notification to change USB preference option.

Figure 24 USB connection notification

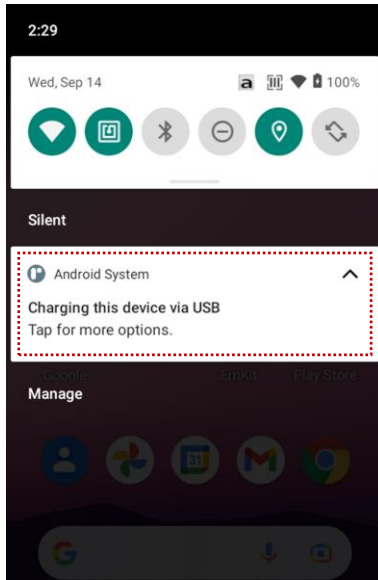

2. Change the option to **File Transfer** from **No data transfer**.

Figure 25 USB Preferences

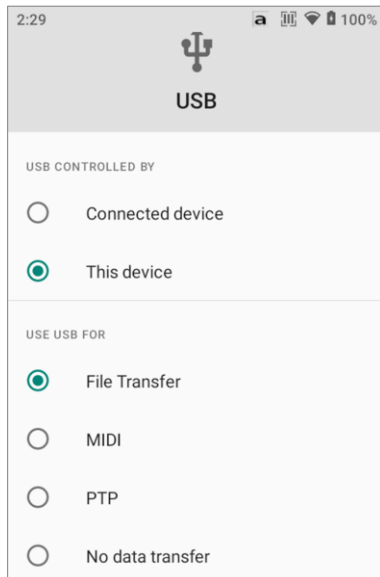

# Learning the Basics

3. Now PC can recognize the connected device. Find PM560 device from file explorer of the PC.

Figure 26 File explorer on PC

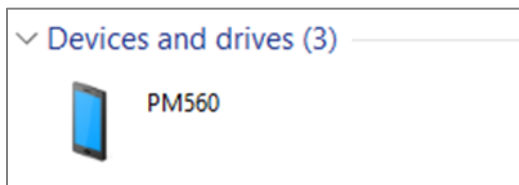

## Manage the Files

Figure 27 FileExplorer main screen

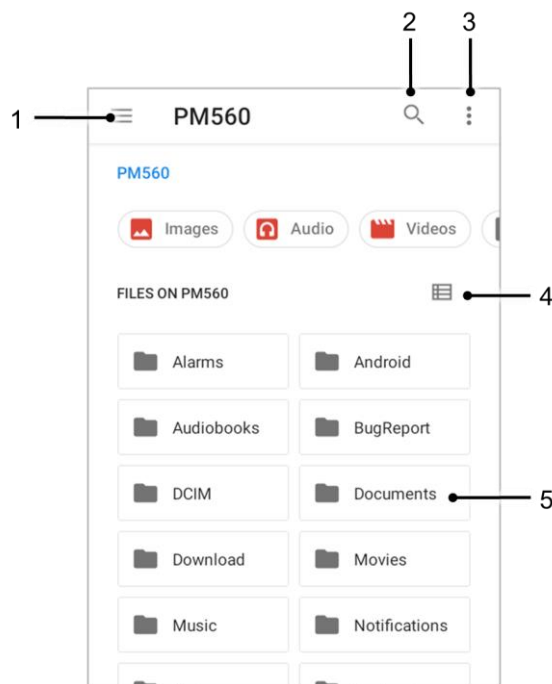

No	Description
1	Select media file type or storage
2	Search a file
3	Open the advanced option – Create a new window or folder, Select all files and folders, etc.
4	Change the view of file list
5	Tap a file or folder to open. Or long-press a file or folder to select

# Learning the Basics

Long-press a file (folder) or tap the icon which is located beside of file name to select the file (folder).

Figure 28 FileExplorer screen when file selected

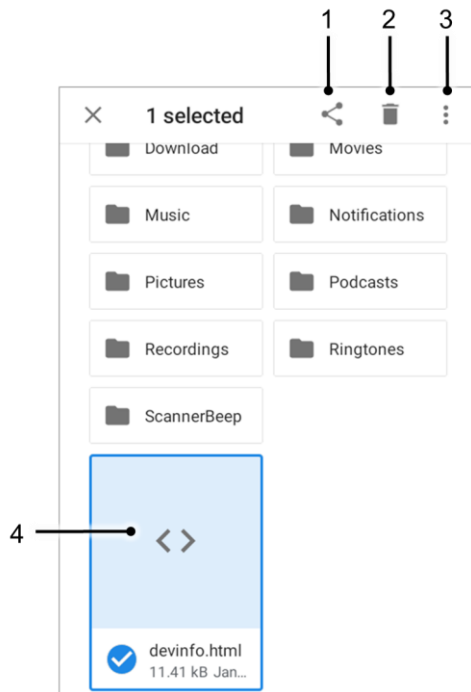

No	Description
1	Share the file via Bluetooth / Gmail / Google Drive, etc. (Sharing is possible only with files)
2	Delete the files or folders
3	Open the advanced option <ul style="list-style-type: none"> <li>- Open with: Select which app to open the file</li> <li>- Sort by...: Sort the list by file name, size, type, etc.</li> <li>- Select all: Select all files and folders</li> <li>- Copy / Move to: Copy or move the file to a new location</li> <li>- Compress: Create Zip file with the selected files or folders</li> <li>- Rename: Rename the file or folder</li> <li>- Get info: Display the file information</li> </ul>
4	Selected file or folder is highlighted



# Learning the Basics

---

## Lock the Screen

Protect the device from unauthorized personnel by setting up the screen lock.



1. Navigate to **Settings**  > **Security** .
2. Tap **Screen lock**.

Figure 29 Screen lock



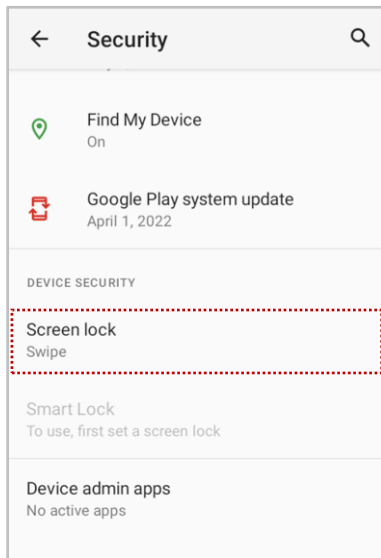

3. Choose a screen lock method.
  - None: Screen unlocks immediately
  - Swipe: Swipe the lock screen to unlock (Default)
  - Pattern: Draw a pattern to unlock
  - PIN: Input a PIN to unlock (At least 4 digits)
  - Password: Input a password to unlock (At least 4 characters)

# Learning the Basics

## Settings

There are two ways to go to **Settings**:

- Open the App drawer and tap **Settings** 
- Open the Quick setting panel and tap gear icon 

## Adjust display brightness

To adjust the display brightness level,



- Open Quick setting panel and adjust display brightness bar
- Go to **Settings**  > **Display**  > **Brightness level**

Figure 30 Normal brightness level



Figure 31 High brightness level (higher than 80%)



**Caution:** Using high brightness levels for long periods may cause eye strain and increase battery consumption.

## Adjust sound

To adjust sound volume, go to **Settings**  > **Sound**  and control the Media, Call, Alarm volume bars.

Figure 32 Volume bars

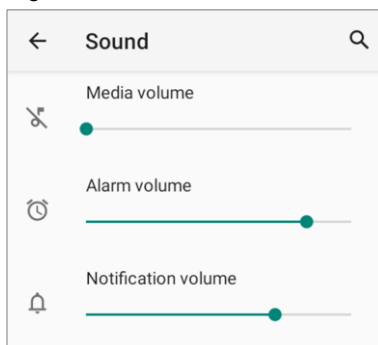

**Caution:** Using high volume levels for long periods may cause ear strain and increase battery consumption.

# Learning the Basics

## Use Keyboard Backlight

The buttons in the keypad may not be visible in the dark. For this inconvenience, PM560 have keyboard backlight so that you can find the proper keys easily.

To use the keyboard backlight,

1. Go to **Settings**  > **Display** 
2. Tap **Keyboard Backlight** switch.

Figure 33 Keyboard Backlight



## Adjust font size

If the font size of the screen is too small or too large, adjust the font size.

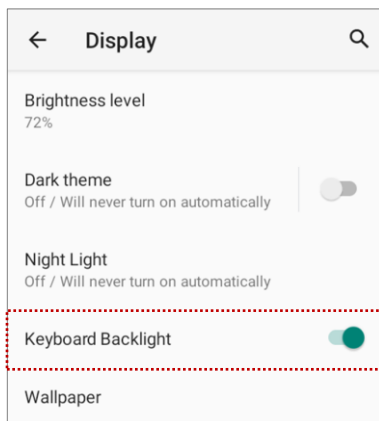

1. Go to **Settings**  > **Display**  > **Advanced** > **Font size**
2. Referring to the **Preview**, set the font size

Figure 34 Set font size





# Using the Keypad

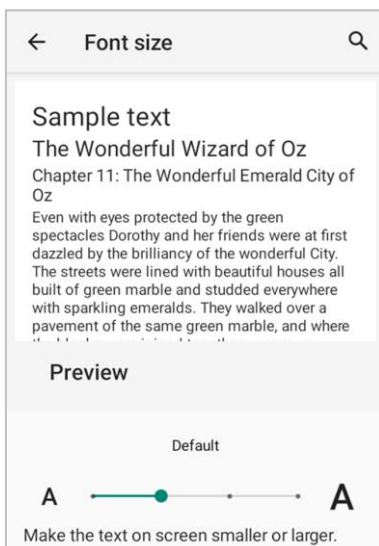

## Alpha-Numeric Keypad

Figure 35 Alpha-Numeric keypad

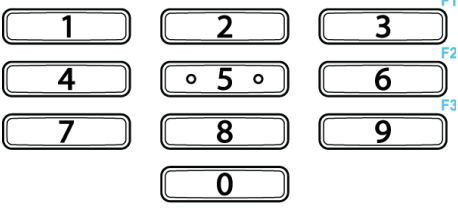



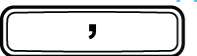
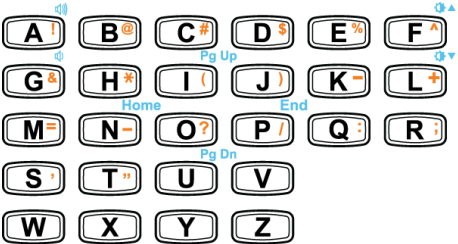

Key	Description
Back 	Back function
Scan (Orange) SCANNER_F 	Scan the barcode
Tab TAB 	Tab function
Numeric 0~9 / Function 1~3 0~9 / F1~F3 	In Default input mode <ul style="list-style-type: none"> <li>Inputs 0 to 9</li> </ul> In Blue functions input mode (3, 6, 9) <ul style="list-style-type: none"> <li>Executes the function mapped to F1 to F3</li> </ul>

# Using the Keypad

Key	Description
Period <i>PERIOD</i> 	Inputs a period
Decimal Point / Function 4 <i>/ F4</i> 	In Default input mode <ul style="list-style-type: none"> <li>Inputs comma</li> </ul> In Blue functions input mode <ul style="list-style-type: none"> <li>Executes the function mapped to F4</li> </ul>
Alphabets 	In Default input mode / In Uppercase alphabet input mode <ul style="list-style-type: none"> <li>Inputs alphabet in uppercase or lowercase.</li> </ul> In Orange function input mode <ul style="list-style-type: none"> <li>Inputs symbols (A~T) marked with <b>orange</b></li> </ul> In Blue function input mode <ul style="list-style-type: none"> <li>Controls screen brightness and volume (A, F, G, L) Refer to <a href="#">Functions</a> section for more detail.</li> <li>Executes functions marked with <b>blue</b> <ul style="list-style-type: none"> <li>I, J: Page up</li> <li>N, O: Move to Home</li> <li>P, Q: Move to End</li> <li>U, V: Page down</li> </ul> </li> </ul>
Enter <i>ENTER</i> 	Enter function

# Using the Keypad



Key	Description
Mode <i>KEYPAD_MODE</i> 	Toggle key for shift mode and orange function input mode.  Press once <ul style="list-style-type: none"> <li>• Activates Shift mode (Input alphabet in uppercase)</li> <li>• The <b>A</b> icon appears on status bar</li> </ul> Press twice <ul style="list-style-type: none"> <li>• Activates orange function input mode.</li> <li>• The <b>Fn</b> icon appears on status bar.</li> </ul> Press three times <ul style="list-style-type: none"> <li>• Back to default input mode.</li> <li>• The <b>a</b> icon appears on status bar</li> </ul>
ESC <i>ESCAPE</i> 	Escape function
Space <i>SPACE</i> 	Space function
Backspace / Delete <i>DEL / FORWARD_DEL</i> 	In Default input mode <ul style="list-style-type: none"> <li>• Backspace function</li> </ul> In Orange function input mode <ul style="list-style-type: none"> <li>• Delete function</li> </ul>
Function (blue) 	Toggle key for blue function input mode.  Press once <ul style="list-style-type: none"> <li>• Activates blue function input mode</li> <li>• The <b>Fn</b> icon appears on status bar</li> </ul> Press two times <ul style="list-style-type: none"> <li>• Back to default input mode.</li> <li>• The <b>a</b> icon appears on status bar</li> </ul>

# Using the Keypad



## Numeric Keypad

Figure 36 Numeric keypad





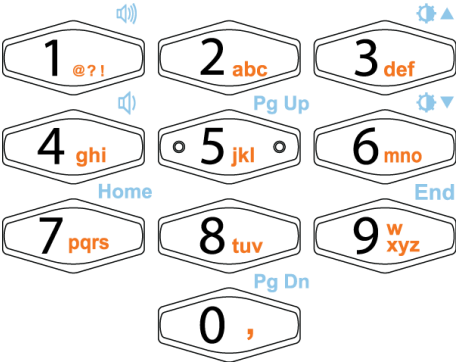
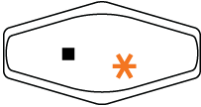

Key	Description
App switch <i>APP_SWITCH</i> 	Displays recent app list screen
Home <i>HOME</i> 	Moves to home screen
Back <i>BACK</i> 	Back function

# Using the Keypad

Key	Description
<p>Numeric 0~9 / Alphabets / Symbols</p>  <p>The diagram shows a numeric keypad with keys 1 through 9 and 0. Each key has a number and a set of symbols or letters. Key 1 has @?! and a speaker icon. Key 2 has abc and a speaker icon. Key 3 has def and a speaker icon. Key 4 has ghi and a speaker icon. Key 5 has jkl and a speaker icon. Key 6 has mno and a speaker icon. Key 7 has pqrs and a Home icon. Key 8 has tuv and a Pg Dn icon. Key 9 has wxyz and an End icon. Key 0 has a comma and a Pg Dn icon.</p>	<p>In Default input mode</p> <ul style="list-style-type: none"> <li>Inputs 0 to 9</li> </ul> <p>In alphabet (orange) input mode</p> <ul style="list-style-type: none"> <li>1: Inputs symbols (@, ?, !)</li> <li>2~9: Inputs alphabet in uppercase or lowercase</li> <li>0: Inputs comma</li> </ul> <p>In Blue function input mode</p> <ul style="list-style-type: none"> <li>Controls screen brightness and volume (1, 3, 4, 6) Refer to <a href="#">Functions</a> section for more detail.</li> <li>Executes functions marked with <b>blue</b> <ul style="list-style-type: none"> <li>5: Page up</li> <li>7: Move to Home</li> <li>9: Move to End</li> <li>0: Page down</li> </ul> </li> </ul>
<p>Period <i>PERIOD</i></p>  <p>The diagram shows a single key with a period symbol and an asterisk symbol.</p>	<p>In Default input mode</p> <ul style="list-style-type: none"> <li>Inputs a period</li> </ul> <p>In alphabet (orange) input mode</p> <ul style="list-style-type: none"> <li>Input an asterisk (*) symbol</li> </ul>
<p>Enter <i>ENTER</i></p>  <p>The diagram shows a single key with the text 'ENT' and a sharp symbol (#).</p>	<p>In Default input mode</p> <ul style="list-style-type: none"> <li>Enter function</li> </ul> <p>In alphabet (orange) input mode</p> <ul style="list-style-type: none"> <li>Inputs a sharp (#) symbol</li> </ul>
<p>Function 1~4 / Function 5~8 <i>F1~F4 / F5~F8</i></p>  <p>The diagram shows two rows of function keys. The first row has keys F1, F2, F3, and F4. The second row has keys F5, F6, F7, and F8.</p>	<p>In Default input mode</p> <ul style="list-style-type: none"> <li>Executes the function mapped to F1 to F4</li> </ul> <p>In Blue functions input mode</p> <ul style="list-style-type: none"> <li>Executes the function mapped to F5 to F8</li> </ul>









# Using the Keypad

Key	Description
Mode <i>KEYPAD_MODE</i> 	Toggle key for alphabet (Orange) input mode.  Press once <ul style="list-style-type: none"> <li>Activates alphabet lowercase (orange) input mode (Input alphabet in lowercase or input symbol)</li> <li>The <b>a</b> icon appears on status bar</li> </ul> Press twice <ul style="list-style-type: none"> <li>Activates alphabet uppercase (orange) input mode (Input alphabet in uppercase or input symbol)</li> <li>The <b>A</b> icon appears on status bar</li> </ul> Press three times <ul style="list-style-type: none"> <li>Back to default input mode</li> <li>The <b>1</b> icon appears on status bar</li> </ul>
Tab <i>TAB</i> 	Tab function
Space <i>SPACE</i> 	Space function
Backspace / Delete <i>DEL / FORWARD_DEL</i> 	In Default input mode <ul style="list-style-type: none"> <li>Backspace function</li> </ul> In Orange function input mode <ul style="list-style-type: none"> <li>Delete function</li> </ul>
Function (blue) 	Toggle key for blue function input mode.  Press once <ul style="list-style-type: none"> <li>Activates blue function input mode</li> <li>The <b>Fn</b> icon appears on status bar</li> </ul> Press two times <ul style="list-style-type: none"> <li>Back to default input mode</li> <li>The <b>1</b> icon appears on status bar</li> </ul>

# Using the Keypad

## Use the Buttons

### Functions

Function	Description	Key Combination	
		Alpha-Numeric Keypad	Numeric Keypad
			
	Volume up	Fn + A	Fn + 1
	Volume down	Fn + G	Fn + 4
	Display brightness up	Fn + F	Fn + 3
	Display brightness down	Fn + L	Fn + 6

### Screenshot

To take a screenshot, press the following key combination simultaneously.

- **Alpha-Numeric Keypad:** Power button + Enter key
- **Numeric Keypad:** Power button + Home key

# Using the Keypad

## Program buttons

Most buttons on the PM560 except power button can be optimized as you want. To map the button to other functions from default,



1. Navigate to **EmKit**  > **Program Buttons** 
2. Tap **SMART REMAP**. And press a button you want to remap.

Figure 37 Program buttons - button list



**Note:** *SCANNER\_B* indicates the trigger button on the gun handle.

3. Choose a behavior you want to use among the tabs.
4. Tap **APPLY**.

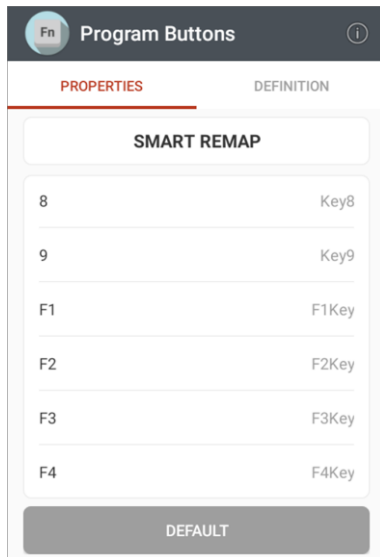
# Scanner

Scanner is placed on the top of the PM560. Optimize the scanner settings for working environment and improve the efficiency.

## Turn on / off the Scanner

The scanner is turned off by default. To turn on the scanner, follow the steps.



1. Go to **EmKit**  or **Settings**  and tap **ScanSettings**.
2. Tap toggle button to turn on/off the barcode scanner.
3. Check if the scanner icon  is placed on Status bar.

Figure 38 Turn on scanner



# Scanner

## ScanSettings

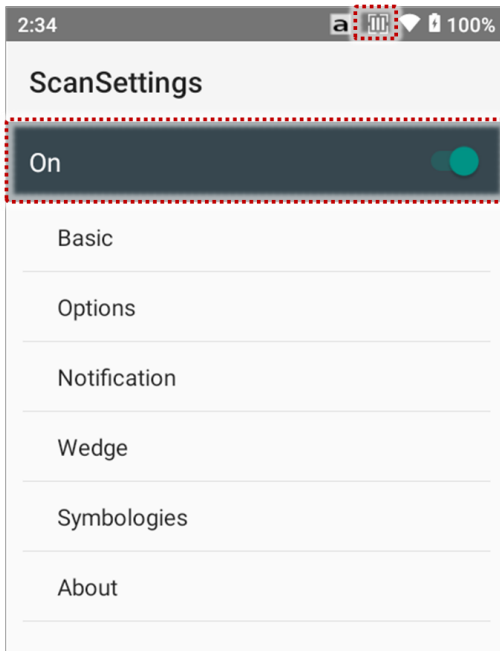
When the scanner is turned on, scanner setting menus will be displayed. **ScanSettings** consists of

- Basic
- Options
- Notification
- Wedge
- Symbologies
- About

### Basic

Control the scanning options and wedge mode options.

#### 1. Scanning

- Change the scanner's trigger timeout and set Auto scan & Continuous scan.
- Enable or disable the TouchScan, which is a software scanner button. Place a scan icon in any position and tap the icon to read a barcode.

Figure 39 ScanSettings - Basic

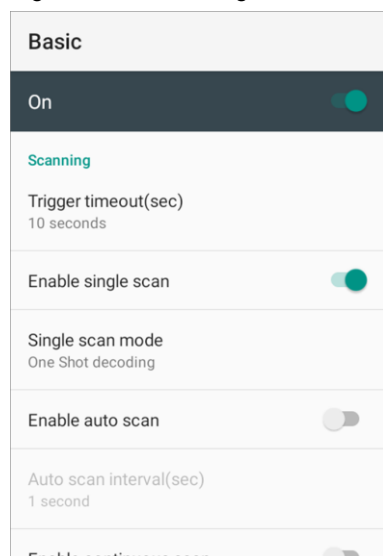
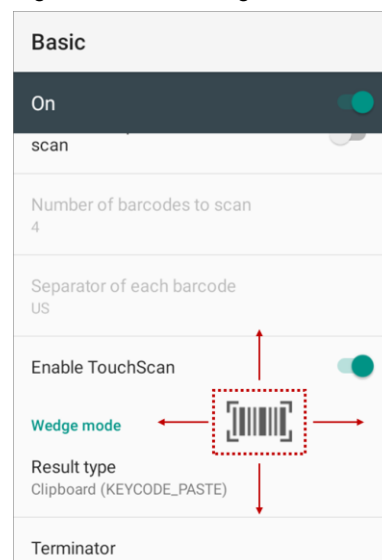

Figure 40 ScanSettings - TouchScan



# Scanner

---

## 2. Wedge mode

- Change the result type of decoded data among the below list.
  - User Message
  - Keyboard Event (Multiple)
  - Keyboard Event (Single)
  - Clipboard (KEYCODE\_PASTE)
  - Clipboard (Ctrl + V)
  - Intent Broadcast
  - Custom Intent
- Set Terminator as,
  - None
  - Space
  - Tab
  - LF
  - Tap & LF

## Options

- Enable / Disable the center window, Aimer, Illumination.

Figure 41 ScanSettings - Options

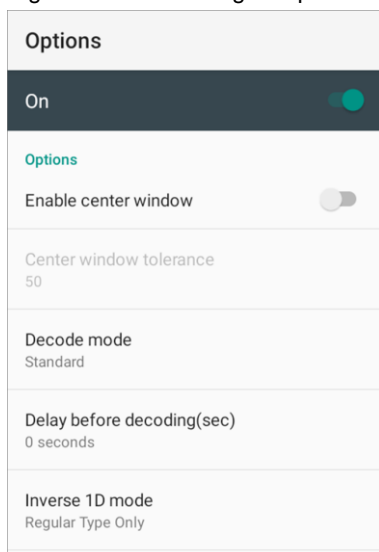

# Scanner

---

## Notification

Control the beep sound, LED and vibration option when scanning the barcode.

Figure 42 ScanSettings - Notification

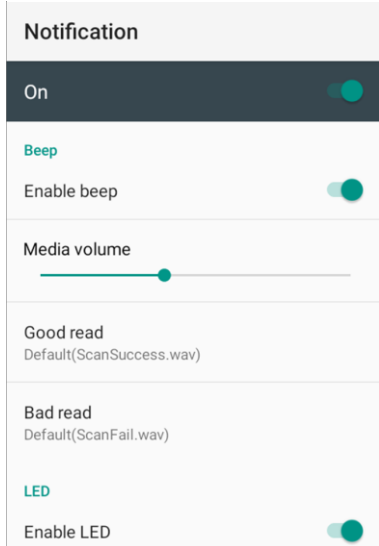

# Scanner

---

## Wedge

Set below items in Wedge settings

- Barcode ID
- AIM ID
- Group separator
- Prefix
- Suffix
- Character set
- Extended Wedge

Figure 43 ScanSettings - Wedge

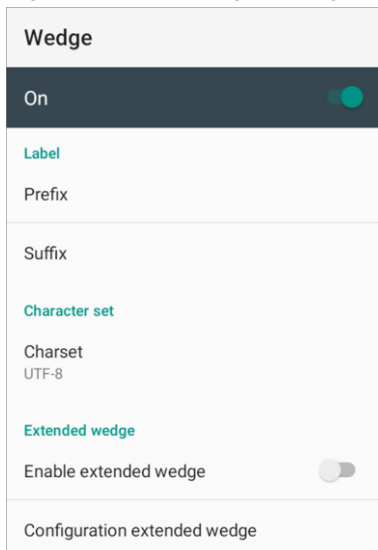



# Scanner

## Extended wedge

PM560 supports Extended wedge that allows to edit the decoded data. Tap **Enable extended wedge** toggle switch and then set a rule in **Configuration extended wedge**.

Figure 44 ScanSettings - Extended wedge

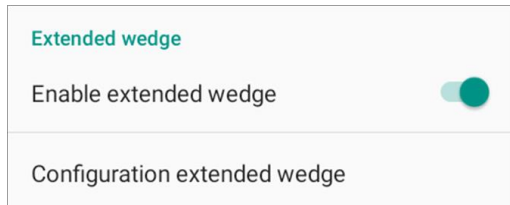

For example, make a rule that add a string “*Point Mobile*” at the start of decoded data whenever decoding CODE128.

1. Tap **Style** (1) and select **Condition** (2).

Figure 45 Extended wedge example\_1

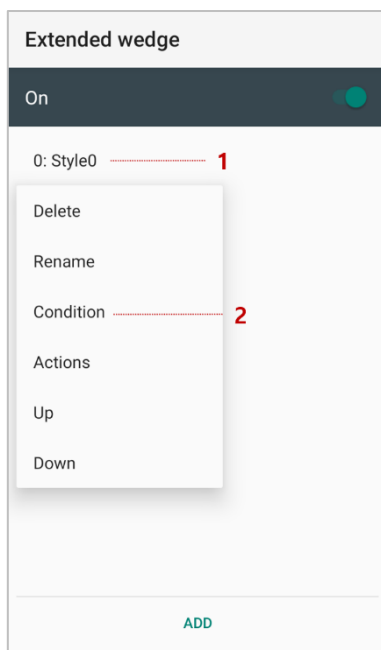

# Scanner

2. Tap **Symbologies** and select **CODE128** among the symbologies.

Figure 46 Extended wedge example\_2

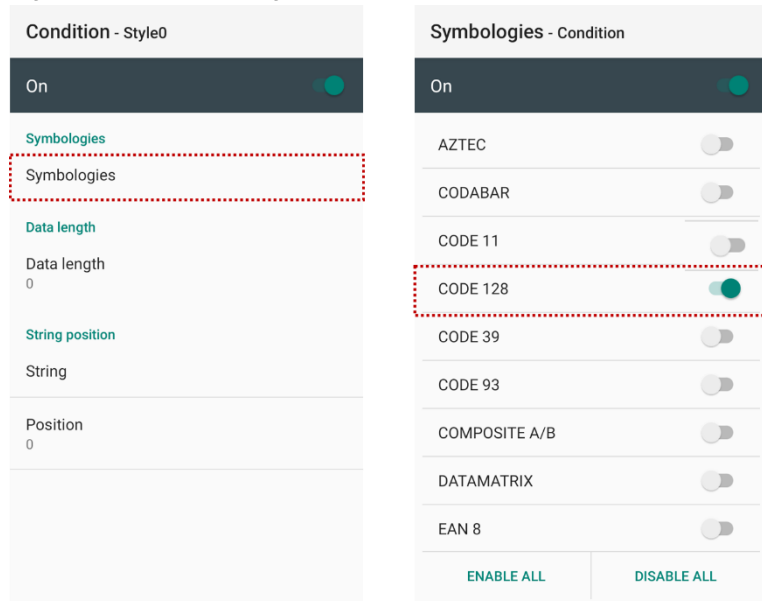

3. Tap **Style (1)** and select **Actions (2)**.

Figure 47 Extended wedge example\_3

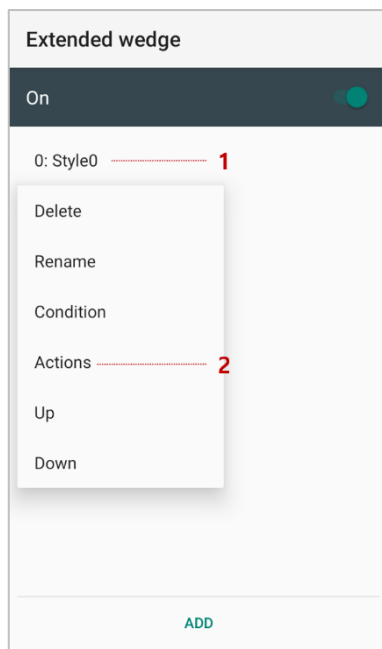

# Scanner

4. Tap **ADD** and select **Move to start** to point the start of the decoded data.

Figure 48 Extended wedge example\_4

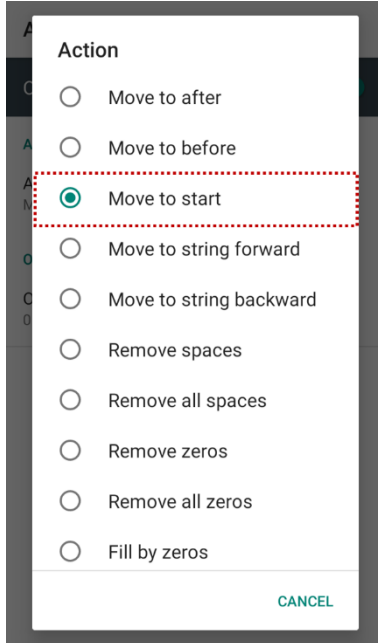

5. Add another action of which action type is Send string. Set value as "*Point Mobile*".

Figure 49 Extended wedge example\_5

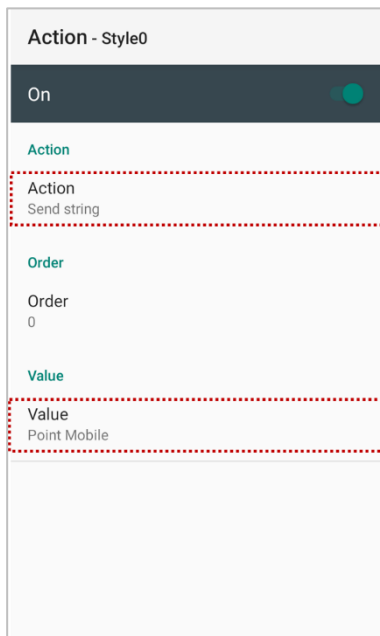

# Scanner

6. "Point Mobile" string will be added to decoded CODE128 data.

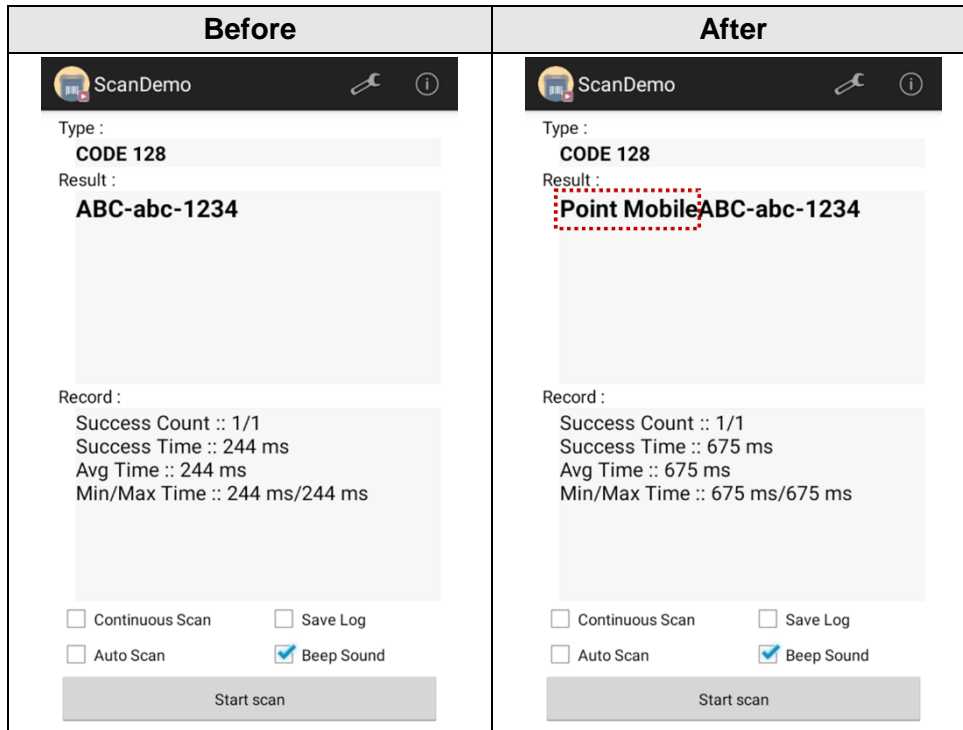

# Scanner

## Symbologies

Enable or disable the specific symbology or set detail options. By tapping each symbology name to access detail options.

Figure 50 ScanSettings - Symbologies

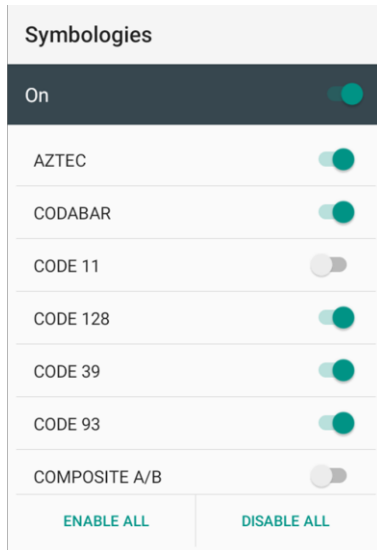

## About

Find the scanner information or restore the scanner settings to default.

Figure 51 ScanSettings - About



# Scanner

---

## Scan a Barcode

Point the scanner at the barcode and press the scan button on the gun handle or on the Alpha-Numeric keypad. If another button is set as scan trigger using Program buttons (Refer to [Use the Buttons – Program buttons](#)), it will trigger the scan action, too.

**i** **Note:** If you set the single scan mode as *Press decoding* or *Release decoding*, it may require another button pressing mechanism to trigger scanning. Refer to [Single Scan Mode article](#) for more detail.

### N6703 Scanner SKU (SKU1)

Center the cross-hair laser aimer over the barcode. The barcode must be within the square made by the edge of the aimer. You can tilt the aimer slightly for a comfortable angle to scan.

Figure 52 Aiming barcode (N6703)



### SE4750 Scanner SKU (SKU2)

Center the cross-hair laser aimer over the barcode. You can tilt the aimer slightly for a comfortable angle to scan.

Figure 53 Aiming barcode (SE4750)

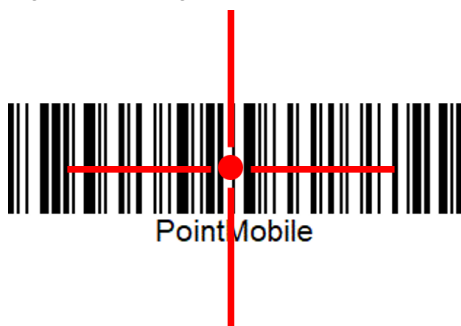

# Scanner

## N6803FR Scanner SKU (SKU3)

Center the green dot aimer over the barcode.

Figure 54 Aiming barcode (N6803FR)

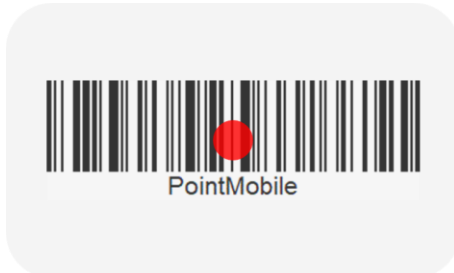

## ScanDemo

Using ScanDemo app, demonstrate scanning feature.



1. Execute **EmKit**  > **ScanDemo** .
2. Scan a barcode by pressing the scan button on the device or tapping **Start scan** button on the screen.
3. Find scan result

Figure 55 ScanDemo



# Wireless

## Wi-Fi

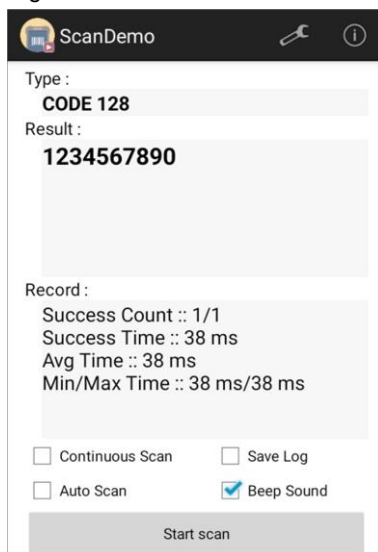
To turn on and connect a Wi-Fi,



1. Go to **Settings**  > **Network & internet**  > **Wi-Fi**.
2. Tap toggle button to enable Wi-Fi.
3. Device searches for nearby Wi-Fi signals and lists them in order of signal strength.
4. Select a Wi-Fi SSID to connect.
5. The message **Connected** under the SSID means the device complete to connect to the Wi-Fi.

Figure 56 Wi-Fi connected



**Note:** There are Open Wi-Fi network and Secured Wi-Fi network. You can tell those apart by lock icon (  ) in the nearby Wi-Fi list.

To connect the secured Wi-Fi network, you need to enter the password.

Figure 57 Open Wi-Fi Network

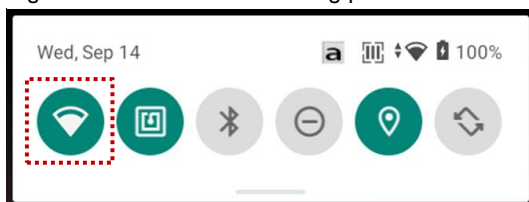

Figure 58 Secured Wi-Fi Network



If there is a saved Wi-Fi network, simply turn on the Wi-Fi through the Quick setting panel. The saved network will be connected automatically.

Figure 59 Wi-Fi in Quick setting panel





# Wireless

## Bluetooth

### Turn on / off

Bluetooth is turned off as default. There are two ways to turn on the Bluetooth,

- Open quick setting panel and enable Bluetooth 

Figure 60 Bluetooth in Quick setting panel



- Go to **Settings**  > **Connected devices**  > **Pair new device**

### Pair and Connect

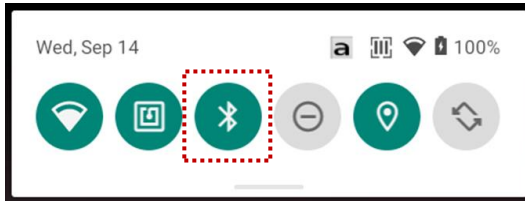
To connect with a new device,



1. Go to **Settings**  > **Connected devices** .
2. Tap **Pair new device**.  
(Bluetooth will be turned on automatically)
3. Select the device you want to pair among **Available devices** list.

Figure 61 Bluetooth available devices



4. Follow instructions on the screen (Pairing code or pairing confirmation dialog) and tap **PAIR**.

# Wireless

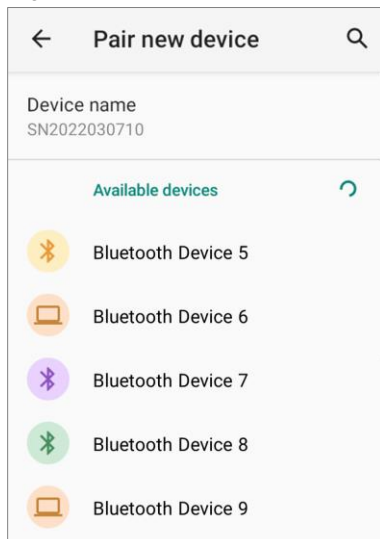
5. When the connection is succeeded, the connected device name is listed on the top of the screen.

Figure 62 Bluetooth currently connected

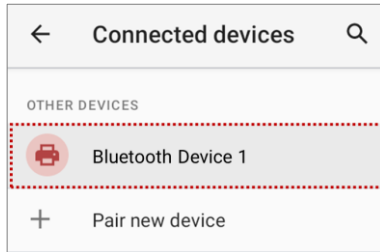

To connect a device previously connected, select the device name from the **PREVIOUSLY CONNECTED DEVICES** list.

Figure 63 Previously connected devices

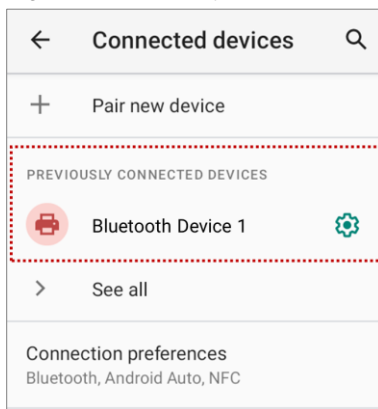

## Unpair and Disconnect

To unpair the device, select the name of the device you want to unpair from **CURRENTLY CONNECTED** list and tap **FORGET** .

Or tap **DISCONNECT**  to disconnect only and not unpair.

Figure 64 Forget device



# Wireless

## Change the Bluetooth device details

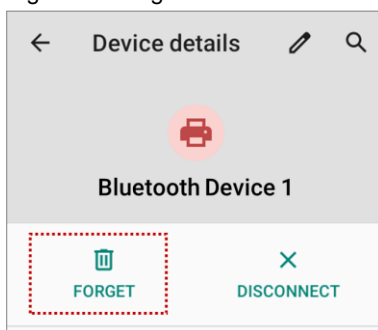
Select a device name from the top list or tap  icon next to the device name from **PREVIOUSLY CONNECTED DEVICES** list.

If no devices are listed under the **PREVIOUSLY CONNECTED DEVICES**, tap **See all**.

Figure 65 Bluetooth device detail

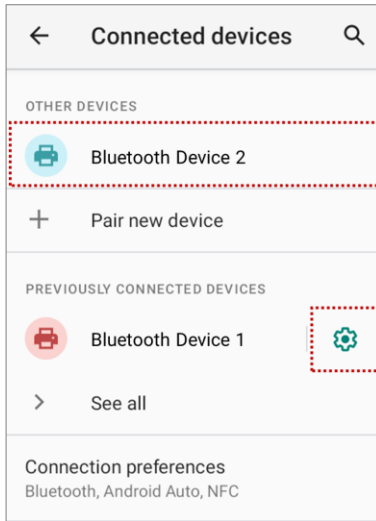

- To change the device's name, tap  on the top of the screen
- Turn other settings on or off (Available on some devices)

## BLE Beacon

The PM560 integrates the BLE beacon that can transmit BLE signal up to **six months** while it is powered off and without the main battery.

This transmission duration is based on the default BLE beacon settings and it can be increased or reduced by adjusting transmit power and interval.

# Wireless

## NFC

PM560's NFC antenna is located on the rear-top side of the device. Bring the NFC tag close to the antenna location as Figure 67.

NFC feature is enabled by default. But if NFC does not work, make sure the NFC  is enabled from the Quick setting panel.

Figure 66 PM560 NFC tapping area

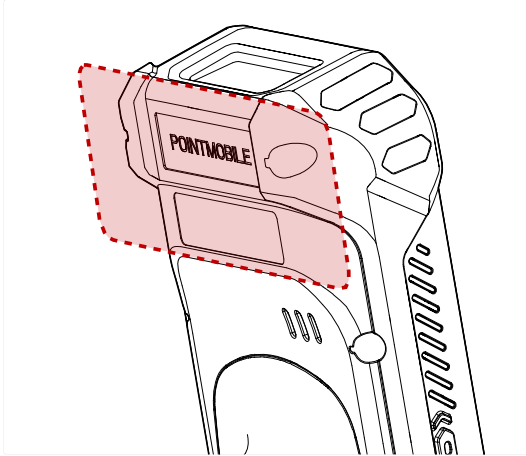
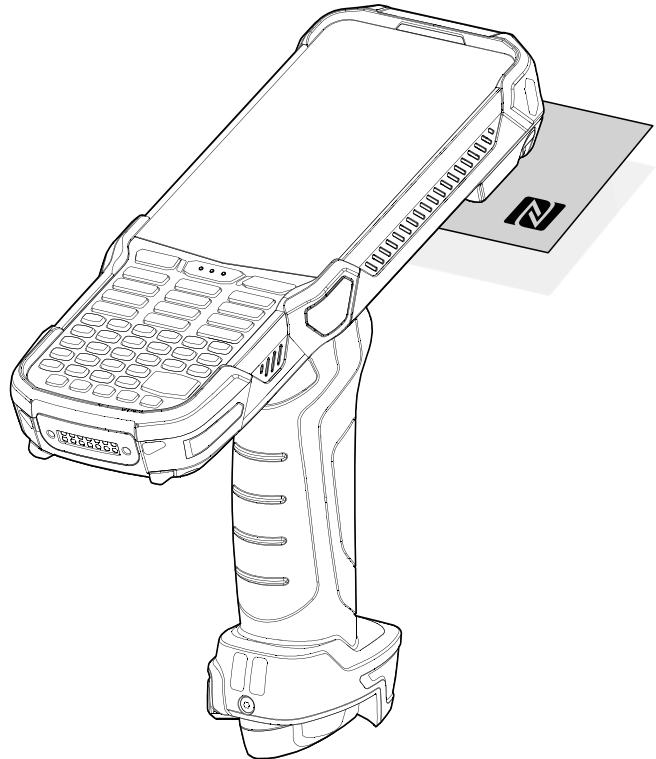

Figure 67 PM560 NFC tapping



# System Maintenance

---

## System Information

There are two ways for checking system information, on settings and on EmKit.

### On Settings

Go to **Settings**  > **About phone** . Following information can be found.

- Device name
- Emergency information
- Legal information & Certificates
- Model
- Hostname
- Android version
- IP address
- Wi-Fi MAC address
- Bluetooth address
- Build number

### On EmKit

Go to **EmKit**  > **System Information** . Following information can be found.

- Processor information
- Version information (Android version, OS image version, SDK version, etc.)
- Manufacturer information (Serial number, Part number, etc.)
- Device information (Scanner, Audio, Display, etc.)
- Battery information (Battery charging status, etc.)
- App version information (Version of EmKit apps)

# System Maintenance

## Check Device Health

EmHealthReport is a solution that provides the device's battery and eMMC health.

Monitor the battery and eMMC status to foresight their lifetime or find the cause when there is a battery problem such as cannot charge the device or rapid battery discharge.



To use, open **EmKit**  and launch **EmHealthReport** . You can see the simple device health information on main screen. To find detailed information, tap each blue arrow on the right side of the screen.

Figure 68 EmHealthReport



- **Battery Health**
  - Battery Level
  - Battery Age
  - Battery Voltage
  - Battery Temperature
  - System Temperature
  - Battery Manufacture Date
  - Battery Serial Number
- **eMMC Health**
  - Pre-EOL Information
  - Device life time estimation type A
  - Device life time estimation type B

# System Maintenance

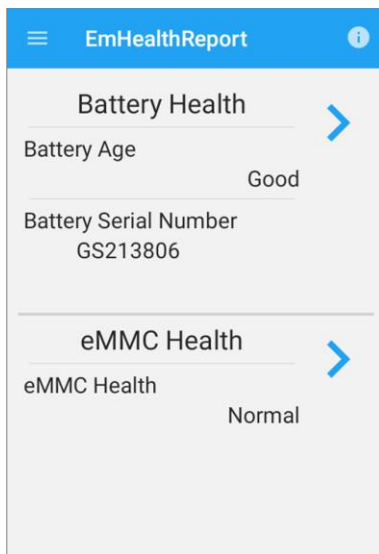
## OS Update

Periodic update improves the performance of the device. Point Mobile provides up-to-date OS version via Service Portal and FOTA. Update the device via storage, OTG port, and FOTA server. Depending on the workspace environment, choose more suitable method.



**Notice:** Please backup your data before starting the update process.

### OS update via storage

To update the OS using storage,



1. Download an OS image file into the root folder of microSD card or device internal storage
2. (In case of using SD card) Insert SD card to the device and then turn the device on
3. Go to **Settings**  > **System**  > **Advanced** > **System Update**
4. Check if the OS image file shows up under **AVAILABLE VERSIONS**

Figure 69 OS update via storage



5. Tap **UPDATE** to start the update process



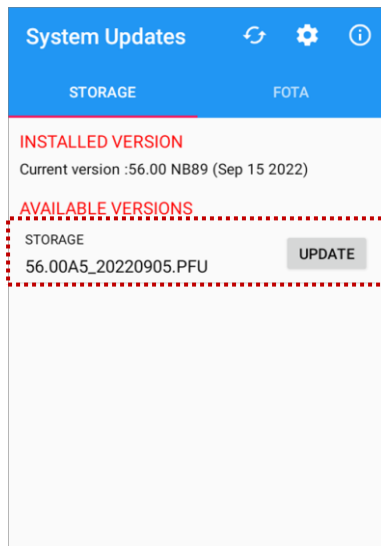

**Note:** If the OS image file doesn't show up in **AVAILABLE VERSIONS**, check the file is placed in the root folder of storage. System only can recognize the file in the root folder.

# System Maintenance

## OS update via OTG port

PM560 supports the USB OTG feature.

1. Prepare a formatted USB flash drive for OS update
2. Copy an OS image file to the root folder of the flash drive
3. Connect the flash driver to the PM560
4. Go to **Settings**  > **System**  > **Advanced** > **System Update**
5. Check if the OS image file shows up under **AVAILABLE VERSIONS**
6. Tap **UPDATE** to start the update process

## OS update via FOTA

If PM560 can connect to a network, use the FOTA server for the update.



1. Connect the device with a network
2. Go to **Settings**  > **System**  > **Advanced** > **System Update**
3. Tap **FOTA** tab or Swipe left to move to **FOTA** tab
4. If there is an OS version newer than device's one, the server shows the new OS information

Figure 70 OS update via FOTA



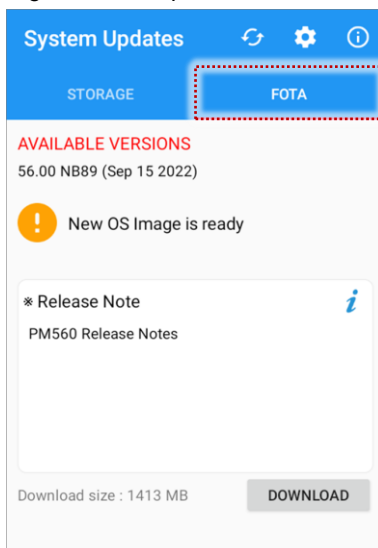

# System Maintenance

---

5. Tap **Download**
6. Tap **OK** on the **OS Update** dialog to start to download the OS image file
7. To complete the update, rebooting is required.

Tap **OK** on the **Restart required** dialog to restart the device

**i** **Note:** Basically, OS update via FOTA works over Wi-Fi or Ethernet only. To enable the OS update over Mobile Network too, uncheck the setting value in FOTA Settings. Downloading over the Mobile network may result in additional charges.

Figure 71 FOTA Settings

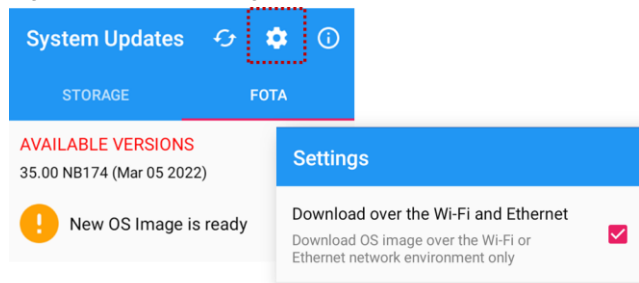

# System Maintenance

## Factory Data Reset

When PM560 work abnormal or there is a need to reset the device, follow the steps below to perform a factory data reset.



**Caution:** Factory data reset will erase all personalized settings and data saved in the device, such as Google account, apps, user data, etc. And factory data reset cannot undo.

### Factory data reset via Settings app

If the device can be turned on and access **Settings**,



1. Navigate to **Settings**  > **System**  > **Advanced** > **Reset options**
2. Tap **Erase all data (factory reset)**
3. After being aware that factory reset will erase all data from the internal storage, tap **Erase all data**

Figure 72 Factory data reset



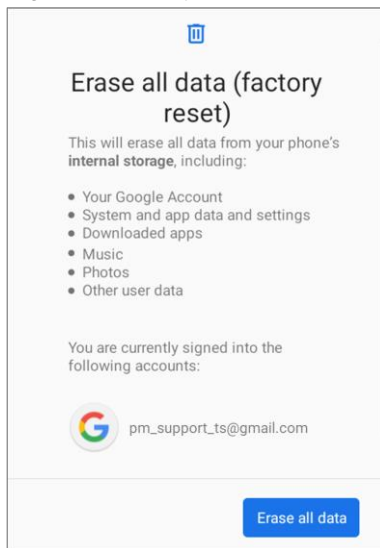

4. Tap **Erase all data** again to start the factory reset process

# System Maintenance

## Factory data reset via recovery mode

If device works abnormal so does not turn on, try to perform factory data reset through Android recovery mode.

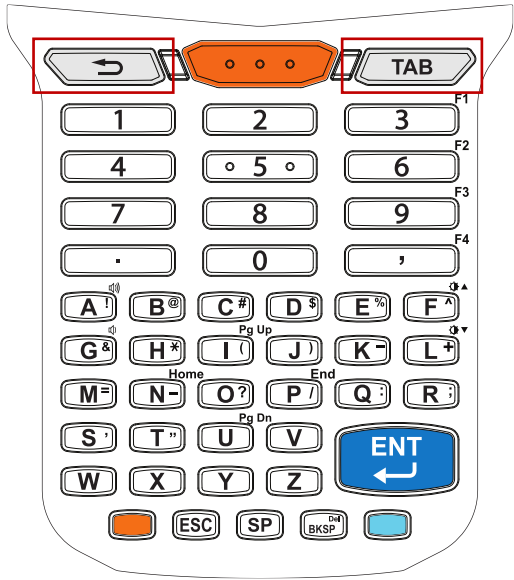
1. Press and hold the following buttons by keypad type simultaneously when PM560 is turned off.

Alpha-Numeric Keypad	Numeric Keypad
Power + Back + Tap buttons	Power + App switch + Back buttons
	

2. After short vibration, release the power button
3. Using the keys below, select **Wipe data/factory reset**
  - **Move down** – Any key except Enter key and Power button
  - **Select the menu** – Press power button or Enter key
4. After wiping the data, select **Reboot system now**

# Accessories

PM560 supports below accessories. All charging cradles are optional accessories (sold separately).

Category	Accessory Name	Usage
Hand strap	Hand strap	Carry PM560 easily
Charging cradle	SSC (Single Slot Cradle) / SEC (Single Slot Ethernet Cradle)	Charge one PM560 and one PM560 battery Provide USB type C port or ethernet port
	4SC (4 Slot Cradle)	Charge up to four units of PM560
	6SBC (6 Slot Battery Cradle)	Charge up to six pieces of PM560's batteries

## Hand Strap

Hand strap is included in PM560 standard package. The hand strap helps users to hold the device easier.

Figure 73 PM560 hand strap

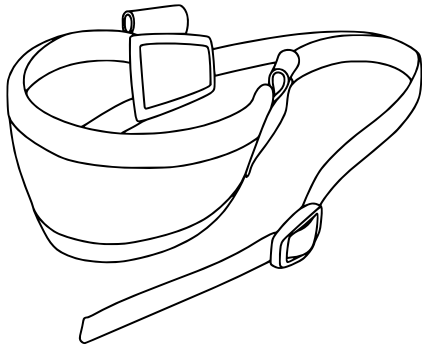

# Accessories

---

## Mount hand strap

1. Thread the strap through the hand strap hole.

Figure 74 Mount hand strap - 1

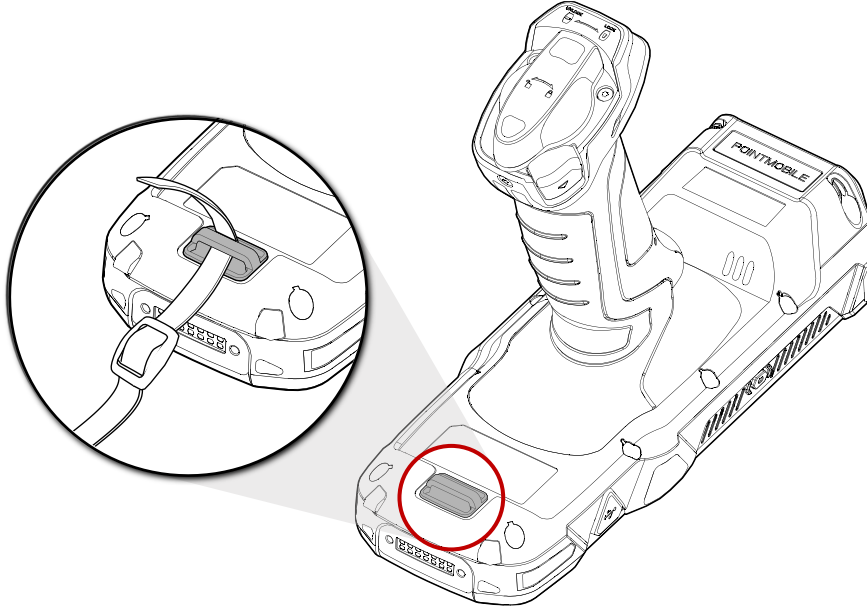

2. Slide the strap through the buckle at the appropriate length, and fasten the strap.

Figure 75 Mount hand strap - 2

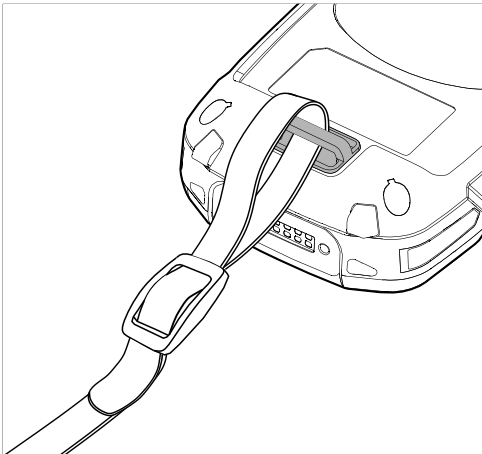

# Accessories

---

## Single Slot Cradle (SSC / SEC)

SSC has one device slot and one battery slot so that it can charge a PM560 and a battery at the same time.

In addition to the charging function, the cradle also provides a USB Type C port.

For more detail, see SSC Quick start guide.

Figure 76 PM560 SSC / SEC

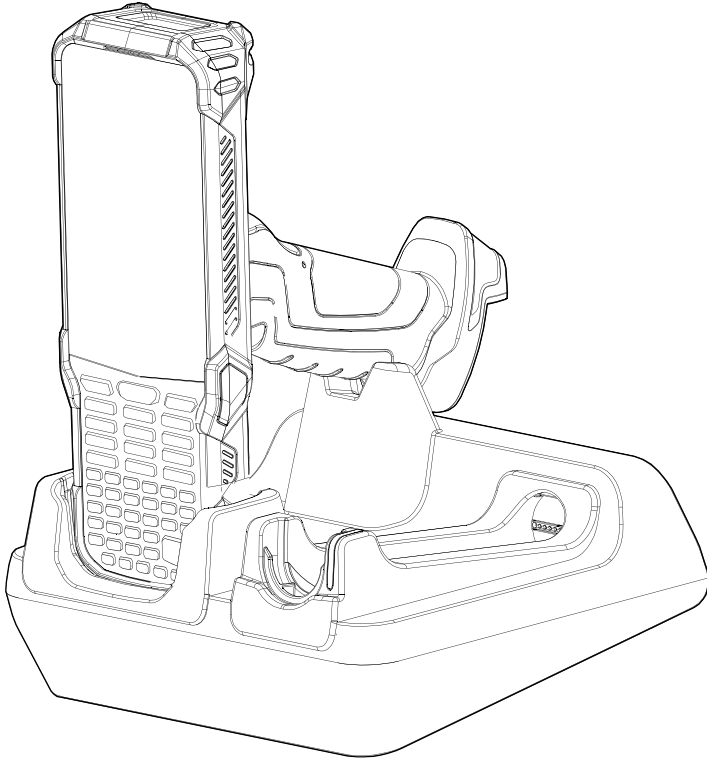

# Accessories

---

## 4 Slot Cradle (4SC)

4SC has 4 device slots so it can charge up to four units of PM560 simultaneously. 4SC is compatible with PM550 and PM560.

Figure 77 PM560 4SC

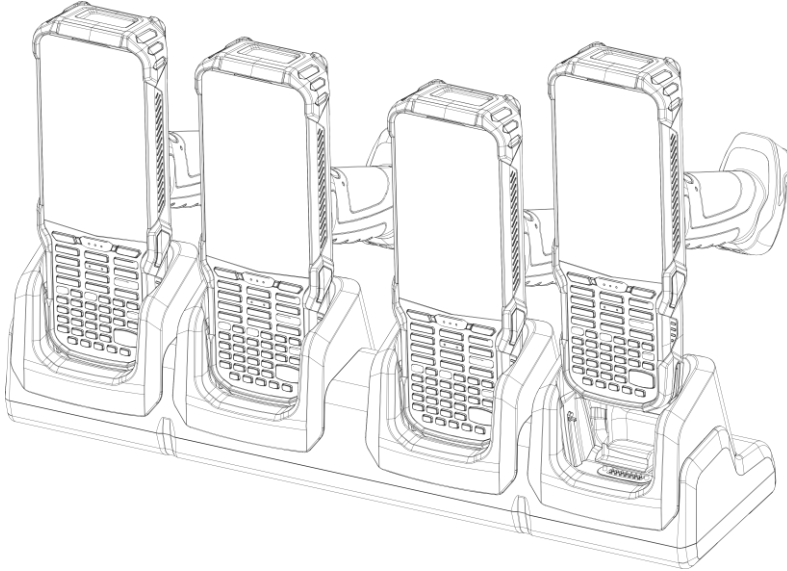

## 6 Slot Battery Cradle (6SBC)

6SBC has 6 battery slots so it can charge up to six pieces of PM560's battery simultaneously. 6SBC is compatible with PM550 and PM560 batteries.

For more detail, see 6SBC Quick start guide.

# Safety Information

---

## Battery Safety Information

Follow the battery safety guidelines for safe usage, storage, and disposal of Li-ion batteries. Improper battery use may result in a fire, explosion, or other critical hazards.

### Battery Safety Guidelines

- Use only Point Mobile approved batteries and charging accessories. Other batteries and chargers may damage the device or result in a fire, leakage, or other hazards.
- Do not expose the battery to excessive heat or cold.
- Do not use or store the battery in or near areas that might get very hot, such as in a parked vehicle, near a heat duct or close to other heat sources.
- Do not allow objects that may cause a short circuit, such as metal objects, corrosive substances, or liquids like water, to contact the battery.
- Do not disassemble, crush, bend, shred, press, or other actions that may damage or deform the battery.
- Do not use or replace the battery on the go or from a high location. Dropping may result in an explosion or fire.
- Do not put any labels, stickers, tags, etc. on the device or battery. Performance of the device or battery, such as sealing, drop, or tumble, could be affected.
- Close supervision is necessary when used near children to avoid the risk of injury.
- If battery leakage is observed, avoid any contact with the skin or eyes and properly dispose of the battery. If contact has been made, wash the affected area with water for 15 minutes and seek medical advice.
- If you notice any type of damage to the battery, such as swelling, dents, and leaks, stop using it immediately and contact Point Mobile.

### Battery Charging Guidelines

- Charge the battery in a clean, cool, dry, and ventilated environment.
- Separate the charger from the battery as soon as possible when the battery is fully charged.
- Battery performance can degrade due to the stress of daily charging and discharging. Batteries typically need to be replaced after 300 to 500 charging cycles (full charge-discharge cycles) or when the battery capacity has been reduced to 70 ~ 80% of its original capacity. The actual number of charging cycles varies based on usage patterns, temperature, age, and other factors.



# Safety Information

---

## Battery Storage / Disposal Guidelines

- Store the batteries in a clean, dry and ventilated environment within ambient temperature ranges of  $20\pm 5^{\circ}\text{C}$ .
- For safety regulations, batteries are charged to below 20~30% of full capacity during production.
- When not using batteries for a long period, charge the battery for 30 minutes to 1 hour at least once every 6 months to prevent full discharge and keep the performance.
- Batteries should be stored separately when storing for long periods. Disconnect from any device, charger, or cradle.
- Dispose of used batteries promptly according to local disposal regulations.
- Do not dispose of the battery in fire. It may cause explosion.



**Notice:** *The battery is consumable. Point Mobile provides a warranty for the battery for 12 months after purchase.*

*If you suspect the battery swelling, change the battery immediately and contact Point Mobile.*



## **Point Mobile. Co., Ltd.**

### **Offline**

Tel: +82-2-3397-7870~1

ARS: +82-1800-3010

Fax: +82-2-3397-7872

Address: 9F Kabul Great Valley, 32, Digital-ro 9-gil,  
Geumcheon-gu, Seoul, Korea 08512

### **Online**

Website: <https://www.pointmobile.com>

E-mail: [pm\\_ta@pointmobile.com](mailto:pm_ta@pointmobile.com)