



For Android™ 9

Enterprise Mobility

PM451

User Manual

Instruction

This manual provides information about basic features and using the PM451. Please read this manual carefully before using your handy terminals and peripherals to ensure safe and proper use.



Note: Screenshots in this manual may differ from actual screens.

Revision History

Revision	Date	Description
V01	26 June 2020	Initial release.
V02	21 Jul 2020	Added mark of microphone and speaker location in Device Parts figures
V03	19 Jul 2021	Added Battery safety information chapter
V04	27 Mar 2023	Updated Battery Safety Information chapter

Table of Contents

INSTRUCTION	1
Revision History	1
TABLE OF CONTENTS.....	2
GETTING STARTED	5
Device Parts	5
Product Standard Accessories.....	7
Setup	8
Install & Remove Battery	8
Remove the battery	8
Install the battery	9
Install SIM card & SD card.....	10
Charge the device	11
Battery Specification.....	11
LED Indicator.....	12
Turn on & off the PM451.....	13
Turn on.....	13
Turn off.....	14
Battery Hot Swap.....	14
Use a touch screen	15
LEARNING THE BASICS.....	17
Setup Wizard	17
Home Screen.....	18
Status Bar.....	19
Status icons.....	19
Notification Icons	20
Notification Panel.....	20
Quick Setting Panel	21

Apps & Widget.....	22
App Folder.....	22
App Drawer	23
Favorites Tray.....	23
Organize App in Home screen.....	24
Widget	24
Recently Used Apps	26
MTP Connection with PC.....	27
Manage Files and Folders	28
Settings.....	30
Adjust Display Brightness.....	30
Adjust Sound	30
Use Keyboard Backlight	31
Adjust Font Size	31
Use a Camera.....	32
SCANNER	33
Turn on the Scanner	33
ScanSettings.....	33
Basic.....	34
Options	35
Notification.....	35
Wedge	36
Extended Wedge.....	36
Symbologies	39
About	39
Scan a barcode.....	40
ScanDemo.....	41
WIRELESS	42
Mobile Network (LTE SKU Only).....	42
Wi-Fi	43
Bluetooth.....	44

NFC	45
SYSTEM MAINTENANCE	46
System Information	46
On Settings.....	46
On EmKit	46
OS Update	47
OS Update via Storage.....	47
OS update from OTG Port.....	48
OS update via FOTA	48
Factory Data Reset.....	50
Factory Data Reset via Settings app	50
Factory Data Reset via Recovery mode	51
GUN HANDLE	52
Attach Gun Handle.....	52
USING THE KEYPAD.....	54
Numeric Keypad	54
Alpha/Numeric Keypad	57
Function/Numeric Keypad.....	60
Functions	63
Program Buttons	64
Microphone.....	65
SAFETY INFORMATION.....	66
Battery Safety Information	66

Getting Started

Device Parts

Figure 1 PM451 front view

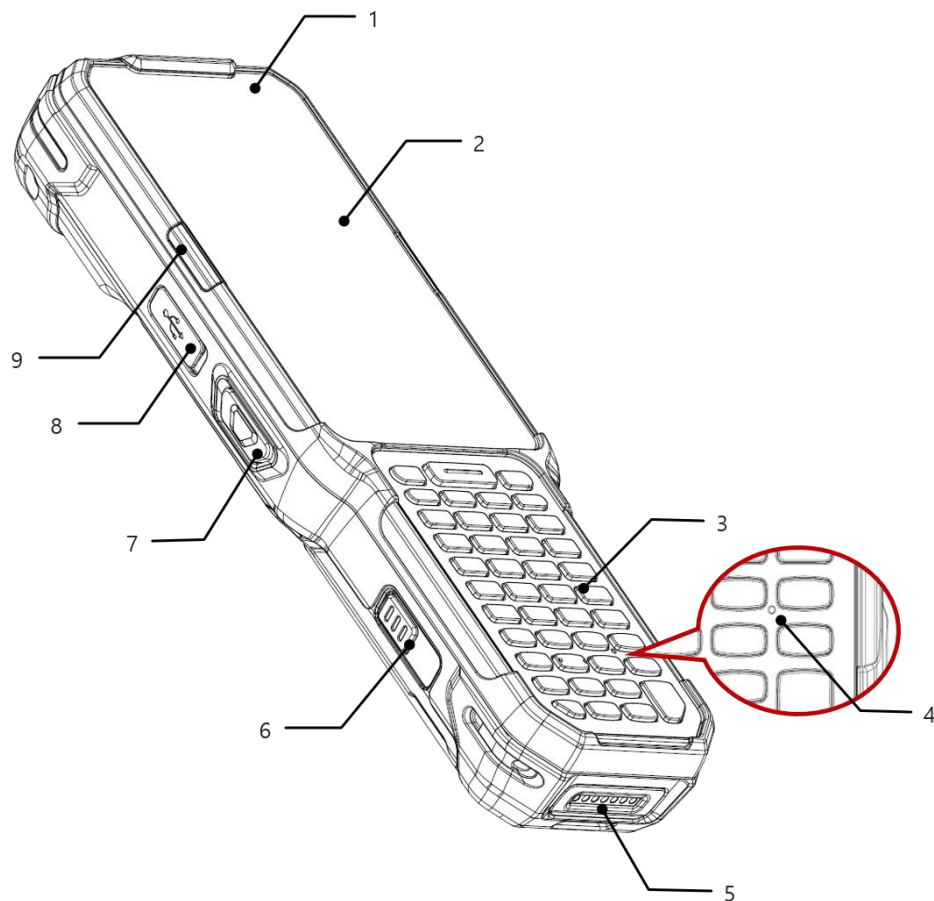

No	Name	Description
1	Front LED indicators	Indicate the power status and notification. See LED Indicator .
2	Display	Display all operating screen
3	Keypad	For detail information, refer to Using the Keypad
4	Microphone	Use for communications. Find the location on the other keypad type in Microphone
5	I/O connector	Pogo 7 pin type I/O connector
6	Battery lock (Left)	Press to release the battery from PM451. For more detail, see Install & Remove Battery
7	Scan button (Left)	Scan a barcode by pressing
8	USB connector with cap	USB 2.0 Type C / OTG
9	Center LED indicator (Left)	Indicates success/failure of barcode reading. See LED Indicator

Getting Started

Figure 2 PM451 Back view

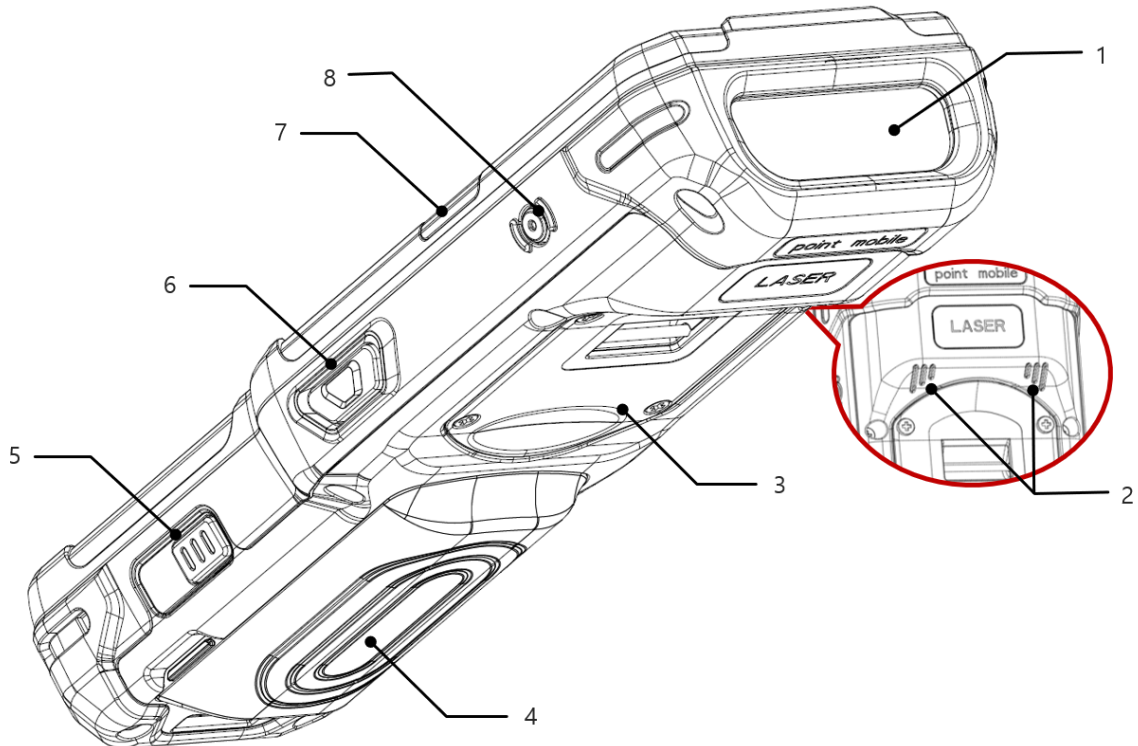

No	Name	Description
1	Scanner & Top camera	Scan a barcode and take a photo
2	Speaker	Provide system and multimedia sound
3	Gun handle connection part	Plug the gun handle. Refer to Gun Handle .
4	Battery	Provide power to device
5	Battery lock (Right)	Press to release the battery from PM451. For more detail, see Install & Remove Battery
6	Scan button (Right)	Scan a barcode by pressing
7	Center LED indicator (Right)	Indicates success/failure of barcode reading. See LED Indicator
8	Power button	Press to turn on/off the device or the screen

Getting Started

Product Standard Accessories

The following items are in the product box.

Accessory	Name
	Extended battery pack (5,700mAh)
	AC/DC power supply
	Country plug (UK / US / EU / KR plug)
	USB type C cable
	Stylus pen and tether
	LCD protection film
	Handstrap

Getting Started

Setup

Install & Remove Battery

Remove the battery

1. Press and hold left & right battery lock simultaneously to release the battery

Figure 3 Press battery lock

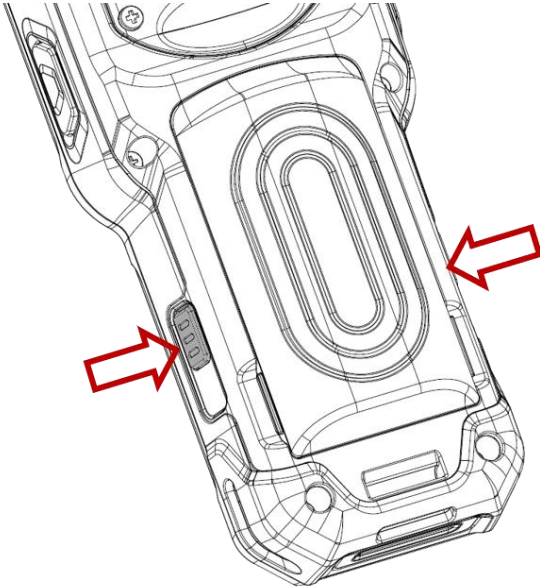

2. Pull up the bottom of the battery to remove from the device and release the battery lock

Figure 4 Remove battery

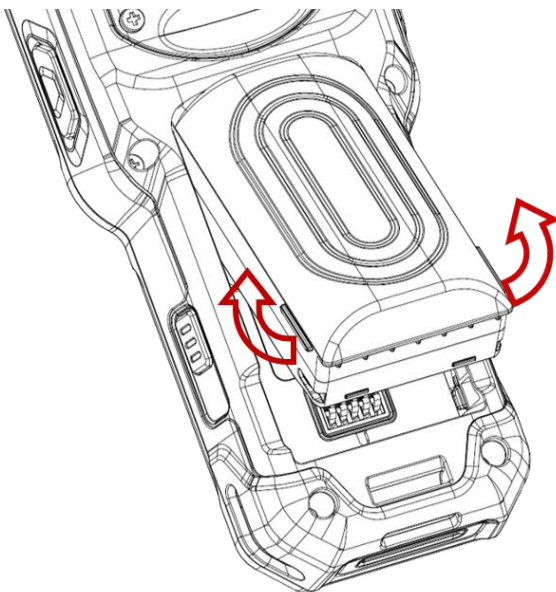

Getting Started

Install the battery

Insert the top of the battery first, and then push down the bottom. Make sure the battery is attached firmly.

Figure 5 Install battery

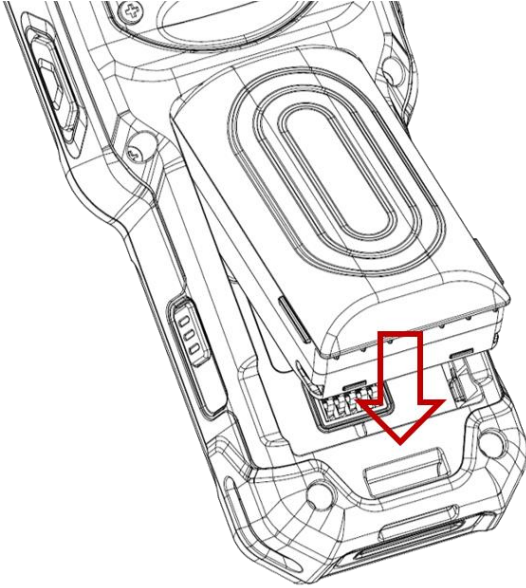

Getting Started

Install SIM card & SD card

PM451 supports micro SIM card(LTE SKU only) and microSD card. Following the steps below, install the cards in the correct slot and the correct orientation.

1. Remove the battery
2. Pull the SIM & SD card slot cap using the hole.

Figure 6 Open SD & SIM card slot

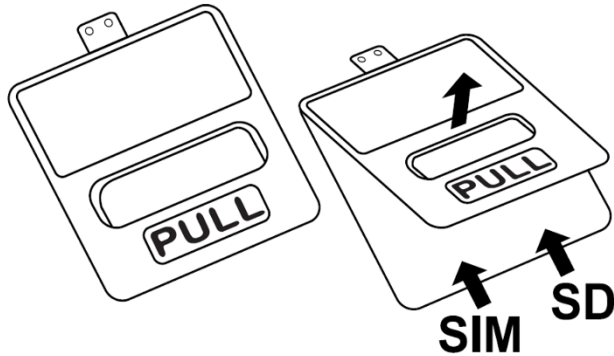

3. Referring to **Figure 7**, insert the cards in the correct orientation. Facing down the gold contact of the cards, insert a micro SIM card on the left and a microSD card on the right.

Figure 7 SIM & SD card slot

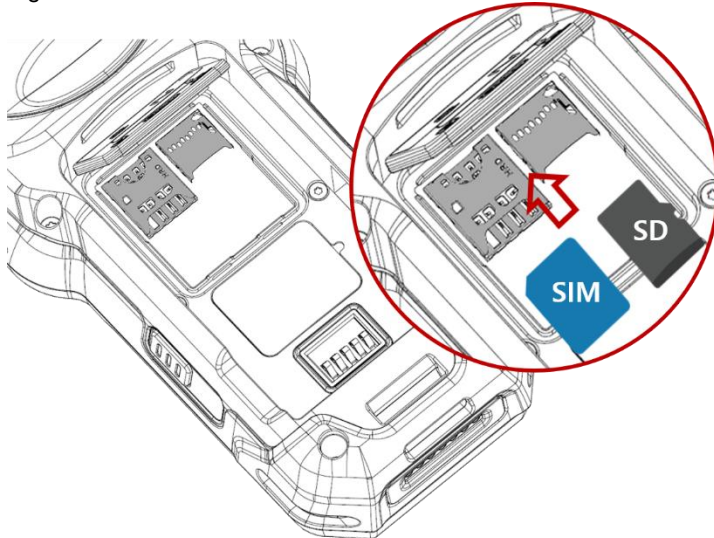

4. To remove the card, gently slide it out of the slot



Caution: Use micro SIM card and microSD card only.

Getting Started

Charge the device

1. Open the cap of the USB connector on the left side of the PM451

Figure 8 Open USB cap

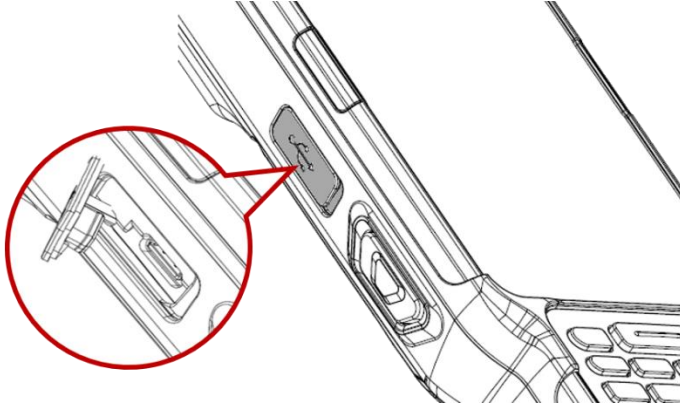

2. Assemble the proper country plug and the AC/DC power supply
3. Plug USB type C cable to the AC/DC power supply
4. Connect the cable to PM451 and provide power by plugging the power supply to the wall socket

Figure 9 Charge PM451

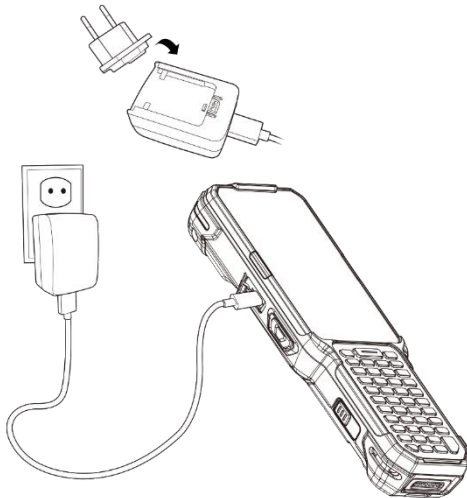

Caution: Always use an original charger and cable from Point Mobile. Other chargers and cables may damage PM451. Also, make sure the charger and cables are not wet.

Battery Specification







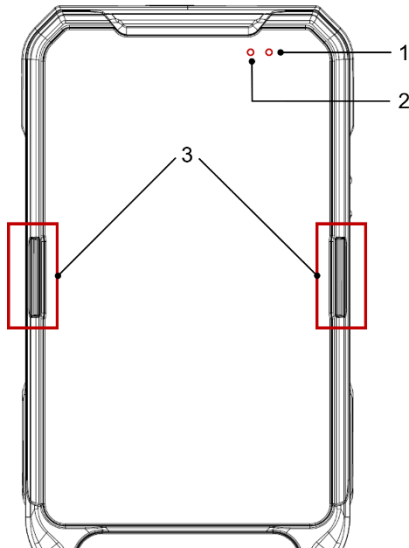

Battery Type	Capacity	Charging time
Extended Battery (Basic)	5700mAh / 3.7V	About 5 hours
Standard Battery	4000mAh / 3.7V	About 4 hours
Backup Battery	60mAh / 3.7V	

Getting Started

LED Indicator

Figure 10 LED Indicator



No	Indicator	Status	Indication
1	Notification LED	 Solid red	Device enters Hot swap mode
		 Solid blue	Device resume from suspend (When the setting is enabled)
		 Blinking blue	Notification existing
2	Power LED	 Solid green	Device is completely charged
		 Solid red	Charging the device / Battery is low
		 Blinking red	Charging temperature is out of normal range / Battery is very low
		 Alternately blinking red & green	Cannot recognize the main battery
3	Center LED	 Solid blue	Barcode reading success
		 Solid red	Barcode reading failed

Getting Started

Turn on & off the PM451

Turn on

1. Press and hold the **Power** button on the right side of the PM451 for a few seconds

Figure 11 Power button

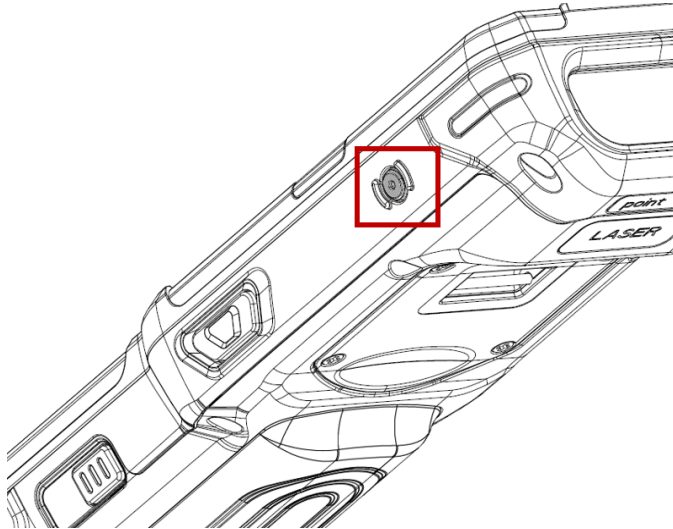

2. When **SMART BEYOND RUGGED** logo displays on the screen, release the button and wait until PM451 finish booting

Getting Started

Turn off

1. Press and hold the **Power** button until the power menu is shown
2. Tap **Power off** among the menu

Figure 12 Power menu

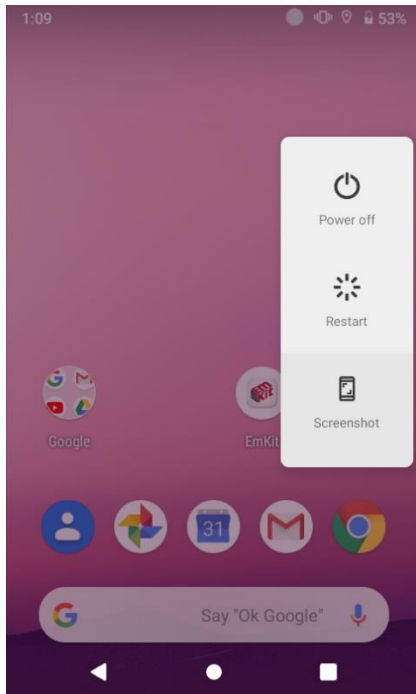



Battery Hot Swap

PM451 provides the Battery Hot swap mode which allows you to replace the battery without turning off the device. When the battery is removed from the device, the display turns off and the device enters Hot Swap mode. In Hot swap mode, data is retained for a while. Once you replace the battery to a new one and lock the Battery lock firmly, the device comes back to normal operation mode without the booting process.

Getting Started

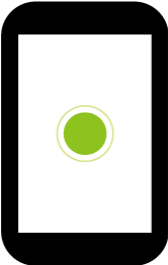
Use a touch screen

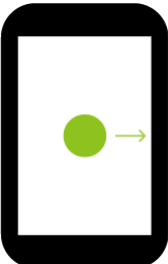
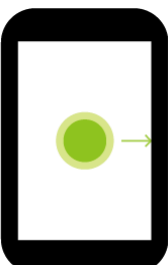
Action	Description
	<p>Tap</p> <p>One-finger press</p>
	<p>Double tap</p> <p>One-finger press, lift, one-finger press, lift for "Zoom in"</p>
	<p>Long-press</p> <p>One-finger press, wait, lift for "Select an item"</p>
	<p>Drag, Swipe, or Fling</p> <p>One-finger press, move, lift for "Scroll" or "Tilt"</p>
	<p>Long-press drag</p> <p>One-finger press, wait, move, lift for "Pick up and move" or "select multiple items"</p>

Getting Started

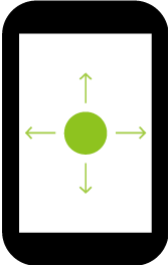
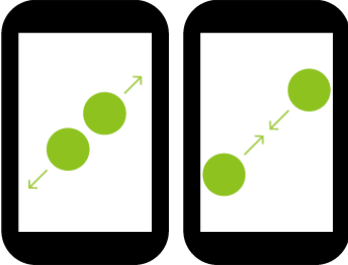
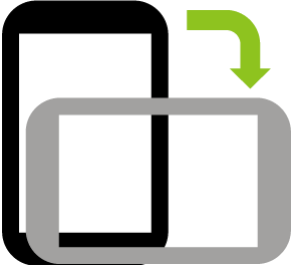
Action	Description
	Scroll Vertical or horizontal swipe in a single direction
	Pinch Open & Close Two-finger press, move outwards and inwards, lift for "Zoom in and out"
	Rotate When PM451 is turning sideways, screen orientation is changing

Learning the basics

Setup Wizard

When you turn on your device very first time or boot after factory reset, you need to set up your device by Setup Wizard.

Following the steps on the screen, set system language, Google account, Wi-Fi connection and copy the data, etc. You can skip some settings, but there may be restrictions on the use of system.

Figure 13 Setup wizard - main

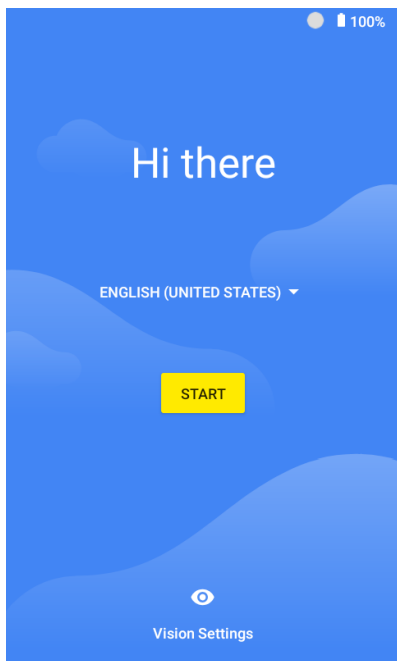
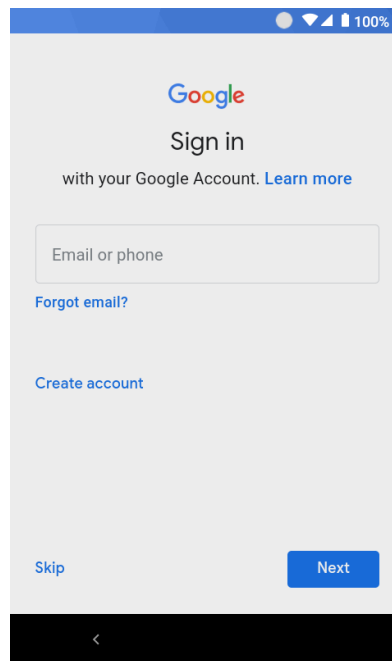

Figure 14 Setup wizard - Google account



Learning the basics

Home Screen

Home screen is a screen you can see when you complete the Setup wizard, press the **Home** button, or unlock the screen.

Figure 15 Home screen

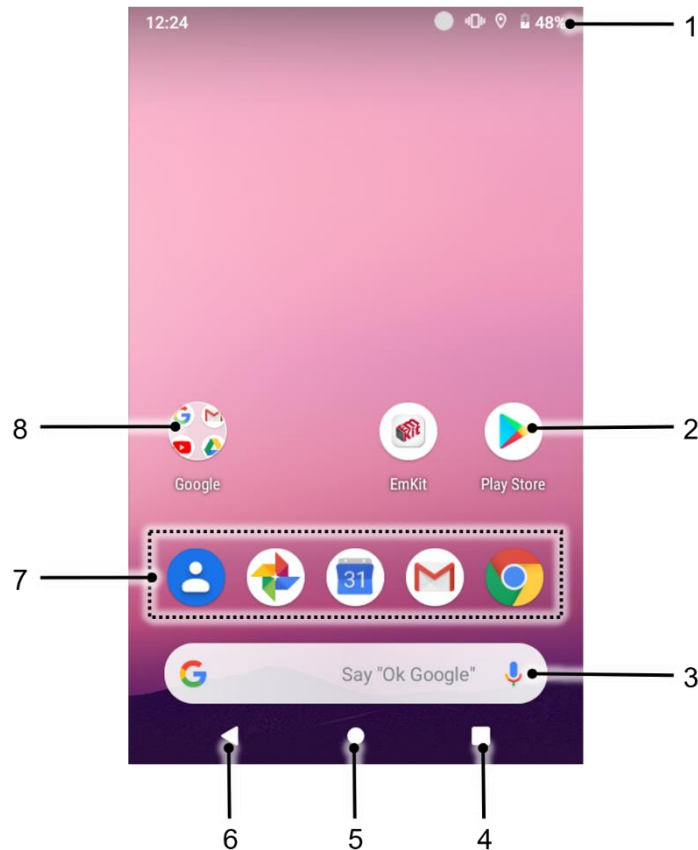































No	Item	Description
1	Status bar	Indicates device status and notification.
2	App	Tap to run the application Long-press to see the application's options
3	Widgets	Simply communicate with the applications on the Home screen
4	Recent apps	Tap to show recently used applications
5	Home	Tap to go to the Home screen
6	Back	Tap to go to the previous screen
7	Favorites tray	Place the frequently used apps
8	App folder	Apps are organized in the folder. Tap to open the App folder

Learning the basics

Status Bar















You can see the time, status icons, and notification icons on the Status bar.

Status icons

Icon	Description	Icon	Description
	EDGE connected		Strong signal
	GPRS connected		Good signal
	3G connected		Weak signal
	LTE connected		Connection issue
	No SIM card installed		No data connection
	Airplane mode		Hotspot enabled
	Data communication		
	Wi-Fi turned on		Connected to a Wi-Fi network
	Bluetooth turned on		Connected to a Bluetooth device
	Battery is full		Battery is partially drained
	Battery is low		Battery is very low
	Battery is charging		
	Location service turned on		Using location service
	Speakerphone turned on		Headset with MIC connected
	Vibrate mode		Phone mic is mute
	Scanner turned on		Alarm is set
	Default input mode		

Learning the basics

Notification Icons

Icon	Description	Icon	Description
	New Email		Connected to VPN network
	Upcoming event		Screenshot captured
	App update available		App updated
	Preparing SD card		SD card removed, unexpectedly
	OTG device connected		Other input method available
	File uploaded		File downloaded
	File copied		
	There are more notifications		

Notification Panel

Notification panel displays a list of all notifications. You can respond to a notification by tapping it. To open the Notification panel, drag the Status bar down. If you want to close the panel, swipe it up.

Figure 16 Notification panel

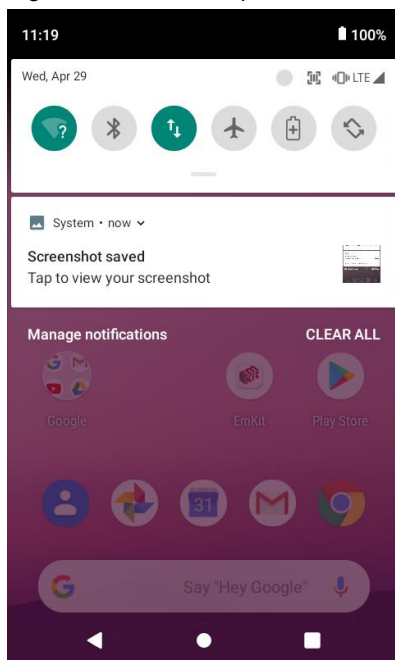

Learning the basics

Quick Setting Panel

In Quick setting panel, you can easily control some frequently used settings such as Wi-Fi, Bluetooth. To use the Quick setting panel,

1. Open the Notification panel
2. Drag down the Notification panel

Figure 17 Quick setting panel

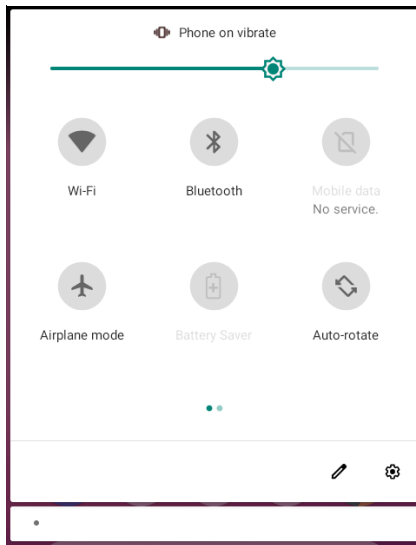

3. Tap a setting icon to enable / disable the setting or long-press an icon to see more detail

If you want to edit the configuration of Quick settings panel,

1. Touch  on the bottom of the Quick setting panel
2. By long-press and dragging the icon, you can customize the configuration of the panel

Learning the basics

Apps & Widget

App Folder

To create the app folder, long-press an app icon and drag it to another app icon.

Figure 18 Create app folder

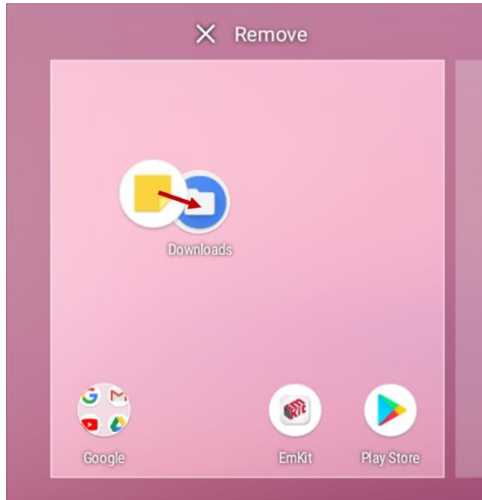

If you want to set the folder name, tap the **Unnamed Folder** and input a new name.

Figure 19 Set app folder name

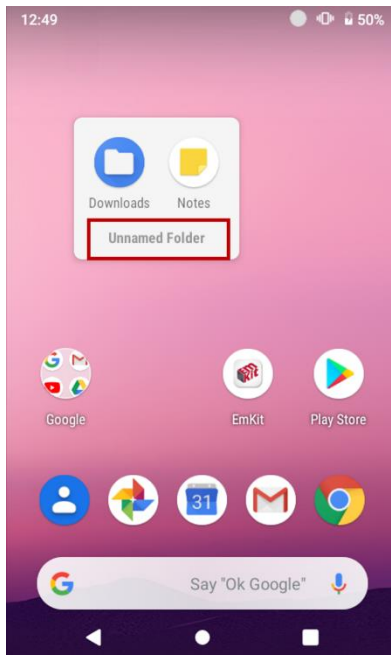

Learning the basics

App Drawer

All installed apps are listed alphabetically in App drawer.

- To open the App drawer, swipe up the Home screen
- To close the App drawer, swipe down the screen

Figure 20 App drawer

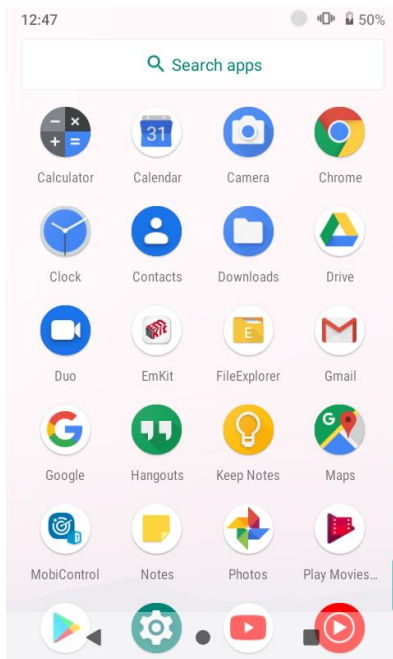

Favorites Tray

To organize an app in the Favorites tray,

1. Long-press an app icon from the App drawer. Then, drag it slightly until the Home screen is shown.
2. Place the app icon in the Favorites tray.

(If a toast message which means there is no room in the Favorites tray, remove an app you don't need from the tray.)

Learning the basics

Organize App in Home screen

To organize an app in the home screen,

1. Long-press an app icon from the App drawer. Then, drag it slightly until the Home screen is shown.
2. Place the app icon where you want

(If you want to cancel to place the app, drag it to **Cancel** area and release)

Figure 21 Place app in Home screen

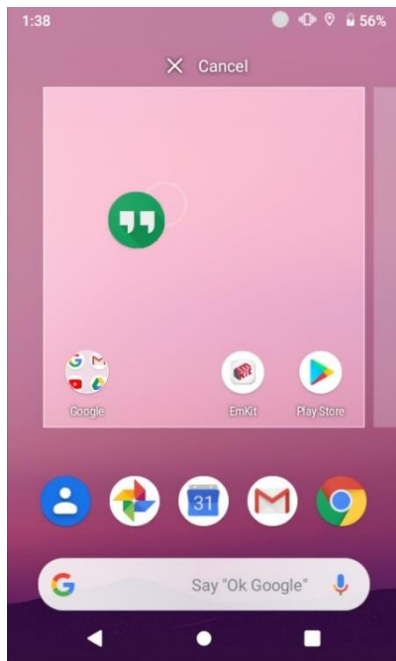

Widget

To add a widget in the home screen,

1. Long-press the empty space of the home screen
2. You can see the three menus, **Home settings**, **Widgets**, and **Wallpapers**

Figure 22 Widget menu

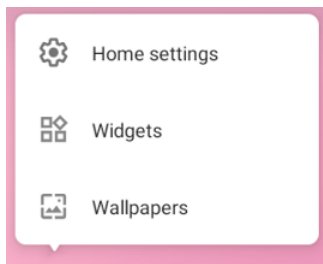

Learning the basics

3. Tap **Widgets**

4. Among the list, tap and hold the widget you want to add

Figure 23 Widget list

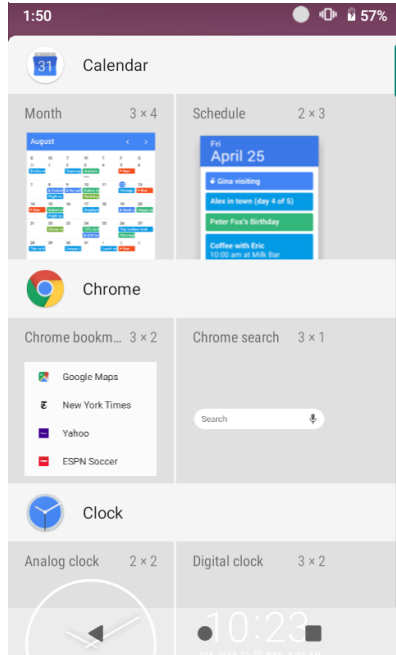

5. Place the widget to the Home screen by dragging



Note: To remove an app or a widget from the Home screen, long-press and drag it to **Remove** area.

Figure 24 Remove from Home screen

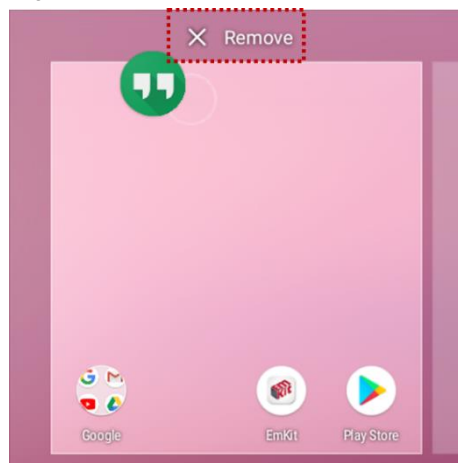

Learning the basics

Recently Used Apps

Tap **Recent apps** button on the bottom of the screen to see recently used apps. You can open an app from the list, or completely close the app by swiping it up.

Figure 25 Recently used apps

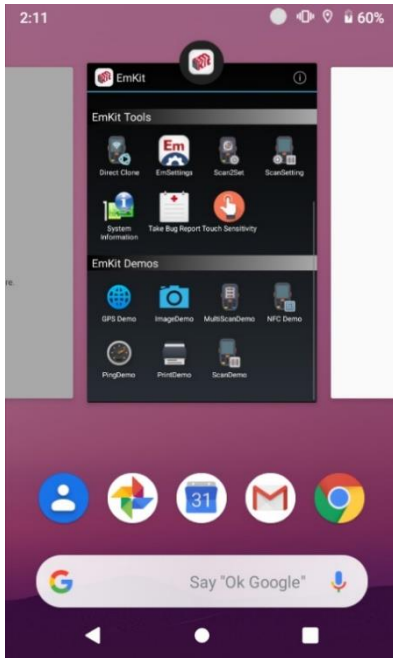

Learning the basics

MTP Connection with PC

To transfer the files with your PC, connect the device to PC via USB cable first.

1. Drag down the Status bar and tap **Android System** notification to change USB preference option

Figure 26 USB connection notification

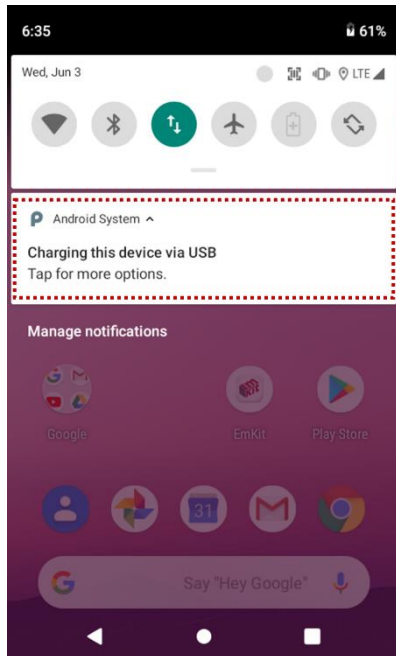

2. Change the option to **File Transfer** from **No data transfer**

Figure 27 USB Preferences setting

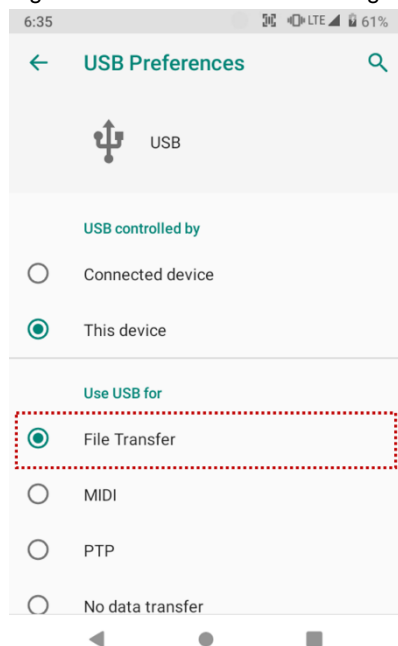

Learning the basics

3. Now your PC recognize the connected device. In file explorer, you can find PM451 device.

Figure 28 File explorer on PC



Manage Files and Folders

To manage or share the files on the device, open **FileExplorer**  in App drawer.

Figure 29 FileExplorer main screen



No	Description
1	Select media file type or storage
2	Search a file
3	Change the view of file list
4	Open the advanced option – Create a new window or folder / Select all files and folders
5	Change the sort – Name / Modified / Type / Size
6	Tap a file or folder to open. Or long-press a file or folder to select

Learning the basics

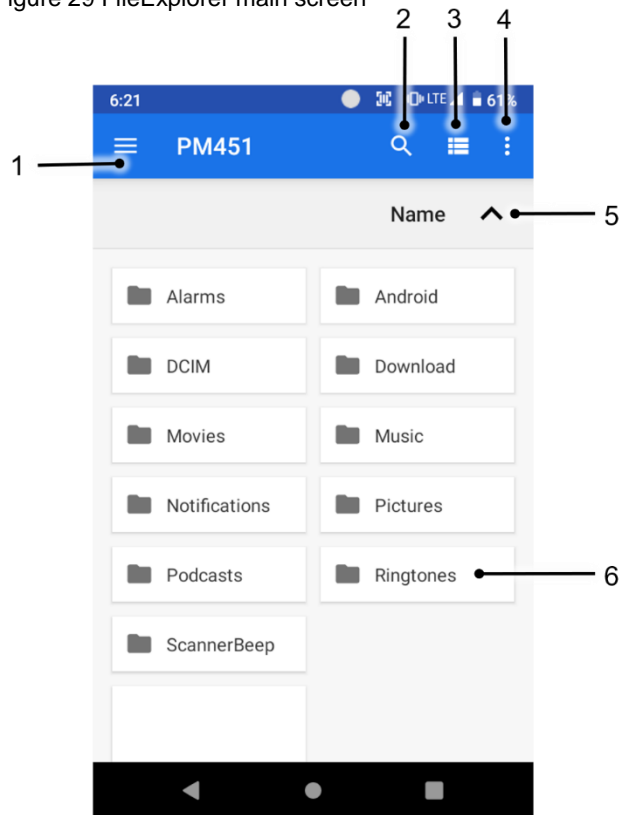
When you long-press a file or folder, the screen changes like below.

Figure 30 FileExplorer screen when file selected

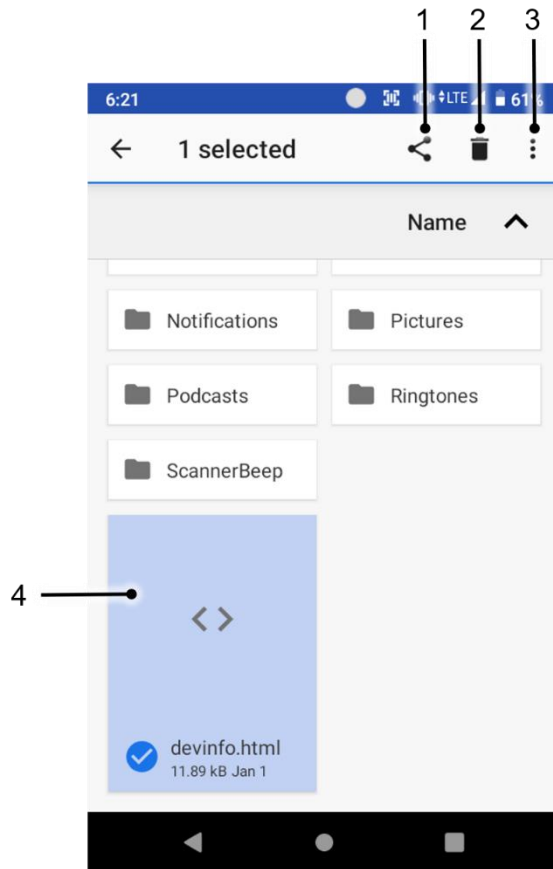



No	Description
1	Share the file via Android Beam / Bluetooth / Gmail / Google Drive, etc. Sharing is possible only with files
2	Delete the files or folders
3	Open the advanced option <ul style="list-style-type: none"> - Open with: Select which app to open the file - Select all: Select all files and folders - Copy / Move to: Copy or move the file to a new location - Compress: Create Zip file with the selected files or folders - Rename: Rename the file or folder
4	Selected file or folder is highlighted

Learning the basics



Settings

There are two ways to go to **Settings**:

- Open the App drawer and tap **Settings** 
- Open the Quick setting panel and tap gear icon 

Adjust Display Brightness

To adjust the display brightness level,

- Open Quick setting panel and adjust display brightness bar
- Go to **Settings**  > **Display**  > **Brightness level**

You can also adjust the brightness using the keypad. See [Keypad – Functions](#).

Figure 32 Normal brightness level



Figure 31 High brightness level (higher than 80%)



Caution: Using high brightness levels for long periods may cause eye strain and increase battery consumption.

Adjust Sound



To adjust sound volume, go to **Settings**  > **Sound**  and control the Media, Alarm, Notification volume bars. You can also adjust the volume using the keypad. See [Keypad – Functions](#).

Figure 33 Volume bar



Caution: Using high volume levels for long periods may cause ear strain and increase battery consumption.

Learning the basics

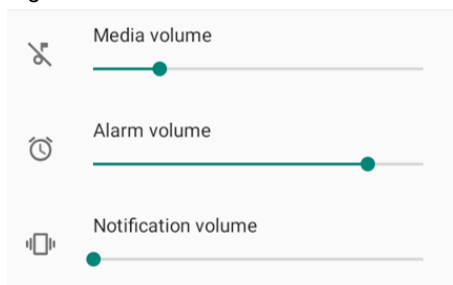
Use Keyboard Backlight

The buttons in the keypad may not be visible in the dark. For this inconvenience, PM451 have keyboard backlight so that you can find the proper keys easily.

To use the keyboard backlight,

1. Go to **Settings**  > **Display** 
2. Tap **Keyboard Backlight** toggle button

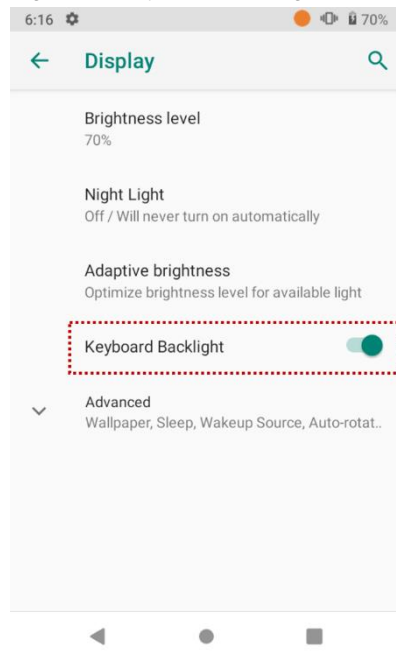

Figure 34 Keyboard Backlight



You can adjust the brightness of the keyboard backlight with the keypad. See [Keypad – Functions](#).

Adjust Font Size

If the font size of the screen is too small or too large for you, you can set the size.

1. Go to **Settings**  > **Display** 
2. Tap **Advanced**
3. Tap **Font size**
4. Referring to the **Preview**, set the font size.

Learning the basics

Use a Camera

PM451 have a camera on the top of the device.

To use the camera, open App drawer and tap Camera application .

Figure 35 is a main screen of Camera application, and **Figure 36** is a screen that is displayed when you swipe the screen to right.

Figure 35 Camera main screen

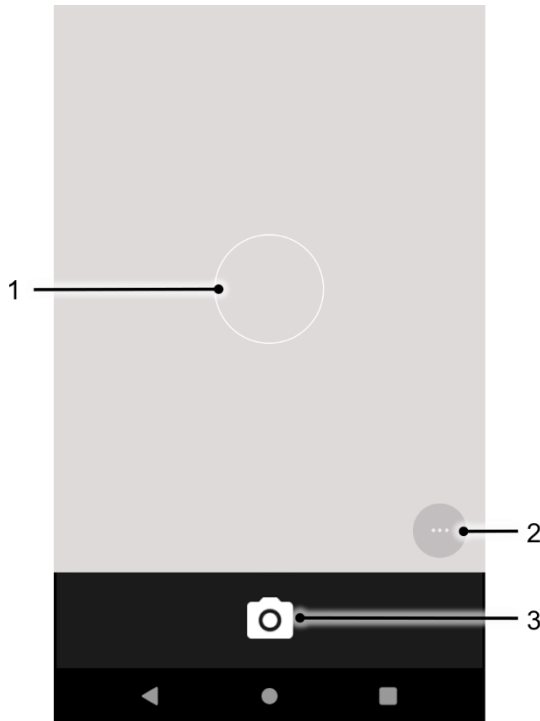
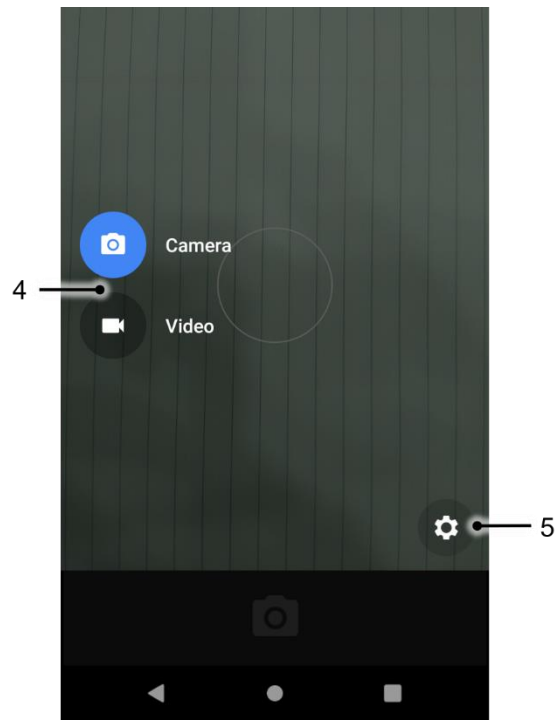





Figure 36 Camera mode change/setting screen



No	Name	Description
1	Focus zone	You can change the focusing area by touching the other area
2	Advanced camera option	 : Set timer  : Display the grid on the screen  : Activate or Deactivate HDR  : Set flash mode (Activate / Deactivate / Auto mode)
3	Shutter button	Take a picture or recode a video
4	Mode change button	Change the Camera or Video mode
5	Advanced camera setting	Set resolution & quality of picture Enable / Disable saving location and manual exposure

Scanner

Turn on the Scanner

The scanner is disabled by default. If you want to enable the scanner, follow the steps.



1. Go to **EmKit**  or **Settings**  and tap **ScanSetting**
2. Tap toggle button to turn on/off the barcode scanner
3. Check if the scanner icon() is placed on **Status bar**.

Figure 37 Enable the Scanner



ScanSettings

If you turn on the scanner, scanner setting menus will be displayed. **ScanSetting** consists of

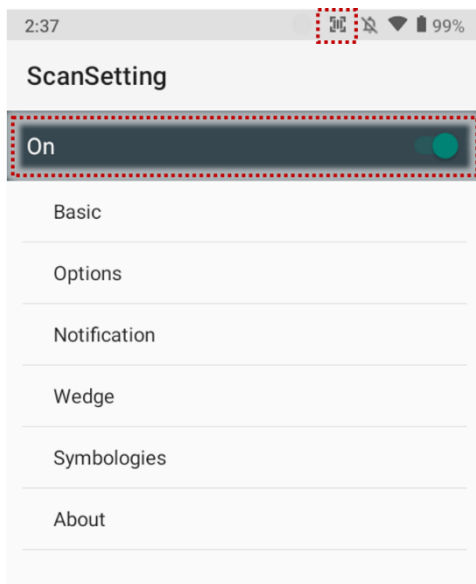
- **Basic**
- **Options**
- **Notification**
- **Wedge**
- **Symbologies**
- **About**

Scanner

Basic

In **Basic**, you can set the **Scanning** option and **Wedge mode** option.

1. Scanning

- You can change the scanner's **trigger timeout** and set **Auto scan & continuous scan**.
- You can use **TouchScan**, which is a software scanner button. Place a scan icon in any position and tap the icon to read a barcode.

Figure 38 ScanSetting - Basic

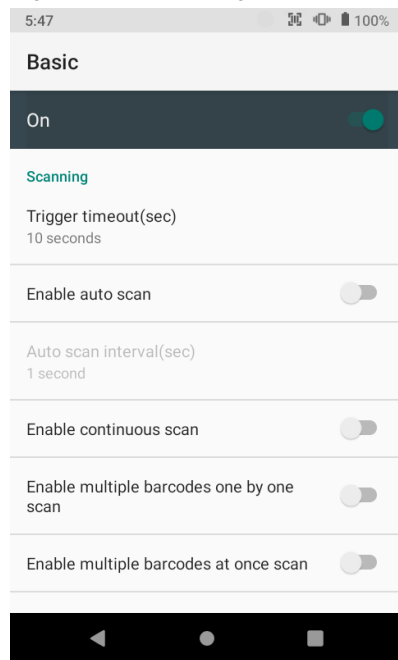
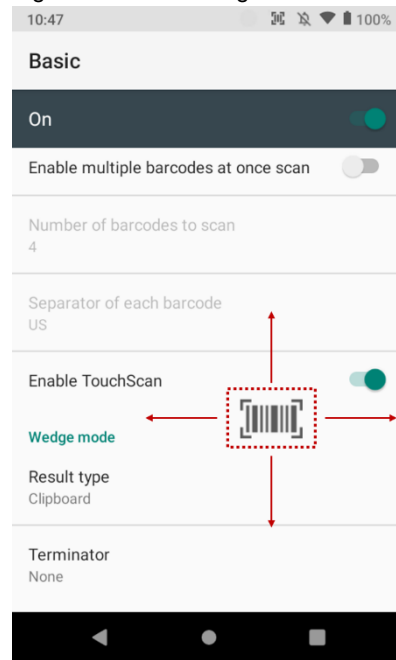

Figure 39 ScanSetting - TouchScan



2. Wedge mode

- You can change decoded scan data's **result type** handling 'User Message', 'Keyboard Event', 'Clipboard', or 'Intent Broadcast'. Also, you can set **Terminator** as 'None', 'Space', 'Tab', 'LF', 'Tap & LF'.

Scanner

Options

In **Options**, you can enable/disable the **center window & Aimer & Illumination** and set **Decode mode & Power save mode**.

Figure 40 ScanSetting - Options

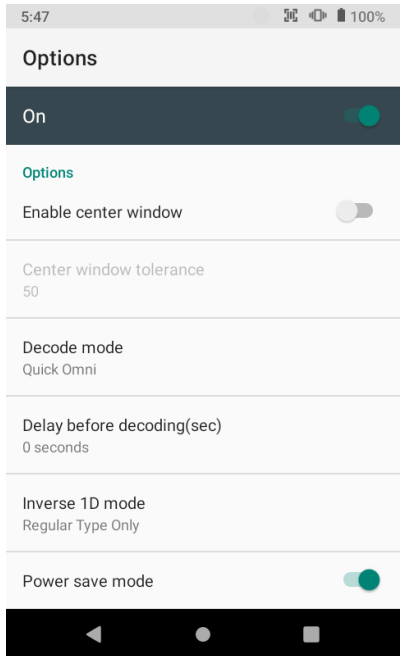

Notification

In **Notification**, you can change or control the **beep sound**, and manage **LED** and **vibration** option

Figure 41 ScanSetting - Notification

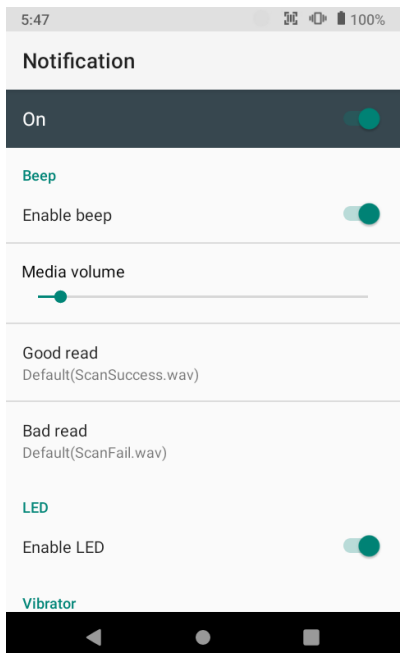

Scanner

Wedge

In **Wedge**, you can enable/disable the **Barcode ID** and **Aim ID**, set **Group separator**, **Prefix & Suffix**, **Character set** and **Extended Wedge**

Figure 42 ScanSetting - Wedge

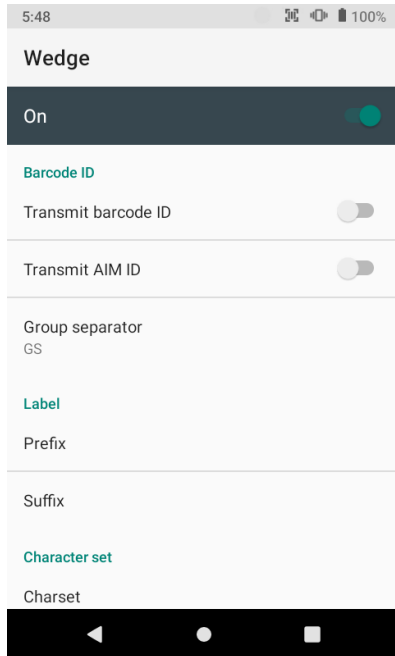

Extended Wedge

PM451 supports Extended wedge that allows you to edit the decoded data. Tap **Enable extended wedge** toggle button, and then set a rule in **Configuration extended wedge**.

Figure 43 ScanSetting - Extended wedge

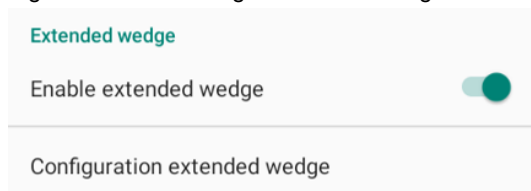

Scanner

For example, if you want to add "Point Mobile" at the start of decoded data whenever decoding CODE128,

1. Tap **Style(1)** and select **Condition(2)**.

Figure 44 Extended wedge example_1

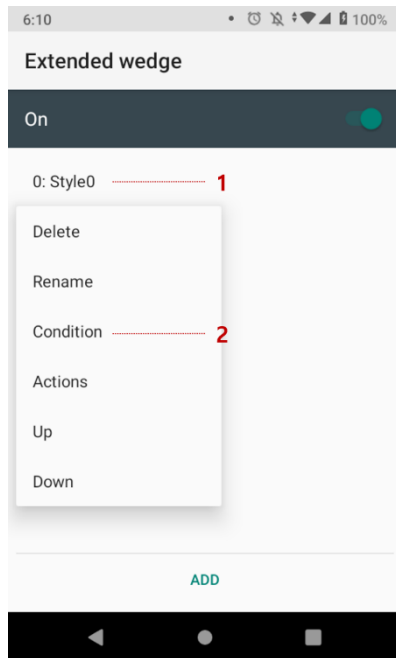

2. Tap **Symbologies** and select **CODE128** between the symbologies.

Figure 45 Extended wedge example_2

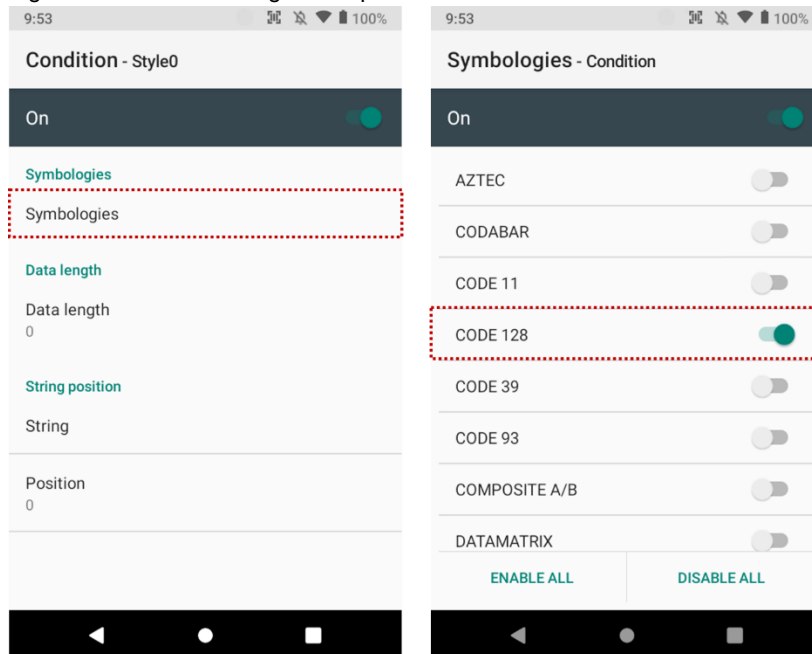

Scanner

3. Tap **Style(1)** and select **Actions(2)**

Figure 46 Extended wedge example_3

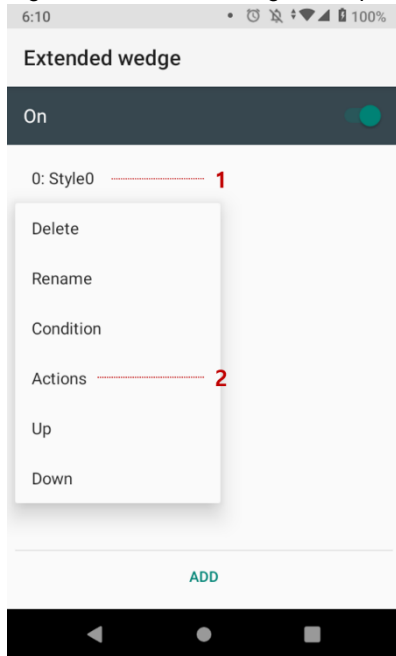

4. Tap **ADD** and select **Move to start** to point the start of the decoded data. And then, add another action of which **action type** is **Send string** and set **value** as "Point Mobile". Now you can get decoded data with "Point Mobile" text.

Figure 47 Extended wedge example_4

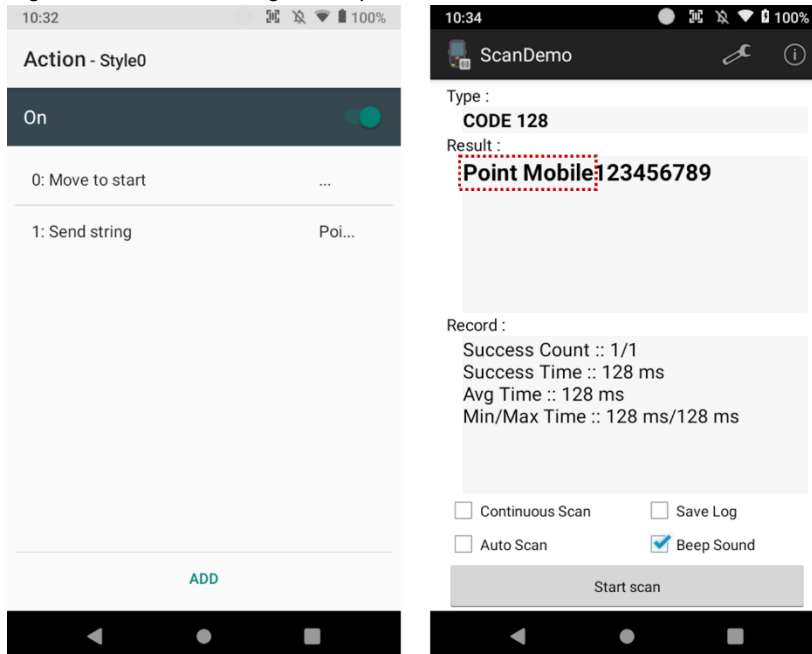

Scanner

Symbologies

In **Symbologies**, you can enable/disable specific barcode type or set a detail option. By tapping each symbology name, you can set detail option.

Figure 48 ScanSetting - Symbologies

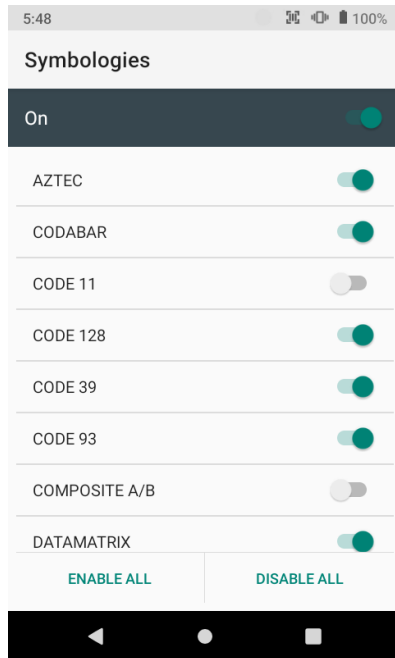
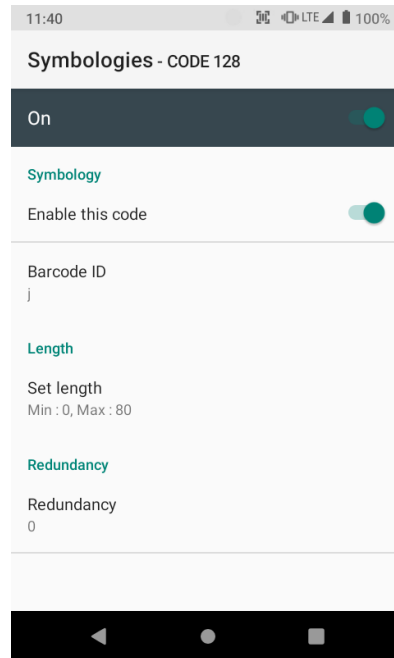

Figure 49 ScanSetting - Select a symbology



About

In **About**, you can find your Scanner's information and restore Scanner's settings to default.

Figure 50 ScanSetting - About

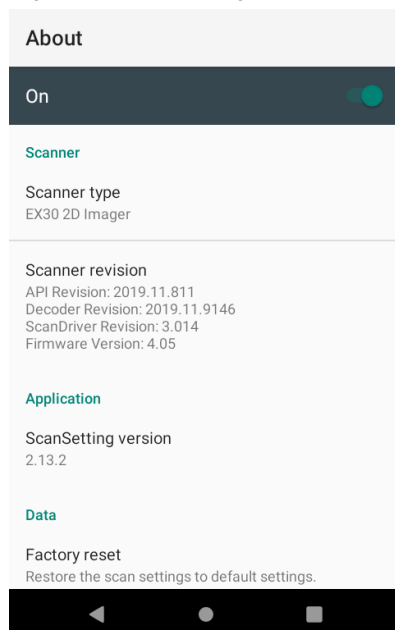

Scanner

Scan a barcode



Idle barcode scan

- Please aim the middle of barcode.
- Even you aim the barcode slightly upper or down area, or angle is slightly tilted, you can read the barcode.

Bad example of barcode reading

- If you aim the barcode wrong direction or tilt too much, you can't read the barcode.
- If you aim part of barcode, you can't read the barcode.

Scanner

ScanDemo

After turning on the scanner, you can test the scan feature with ScanDemo.

1. Execute **EmKit**  > **ScanDemo**
2. Scan a barcode by pressing the scan button
3. Find scan result

Figure 51 Scan Demo

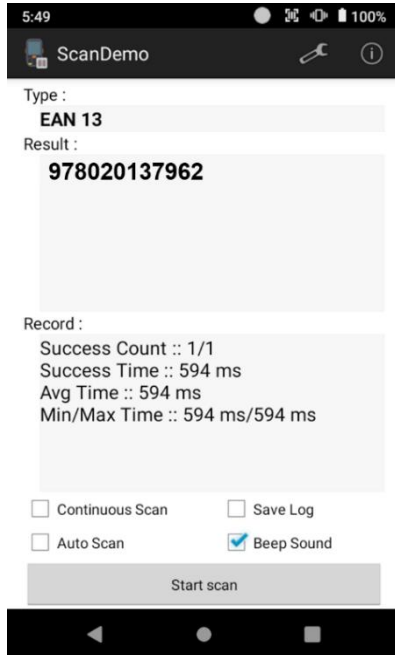

Wireless

Mobile Network (LTE SKU Only)

To connect Mobile network,

1. Insert a micro SIM card to SIM slot. Refer to [Install SIM card & SD card](#)

 **Caution:** Use micro SIM card only.

2. Check if the LTE icon(LTE ) appeared on the status bar. Then, try to access the internet.

Figure 52 LTE icon



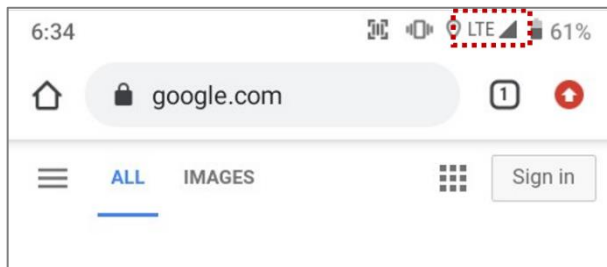

You can find the network information and adjust the network settings in **Settings**  > **Network & internet**  > **Mobile network**. This setting menu can also be accessed by long-press the Mobile data icon in Quick setting panel.

Figure 53 Mobile network setting

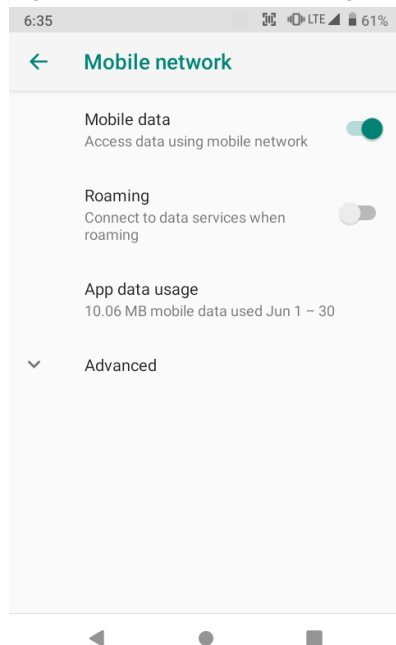
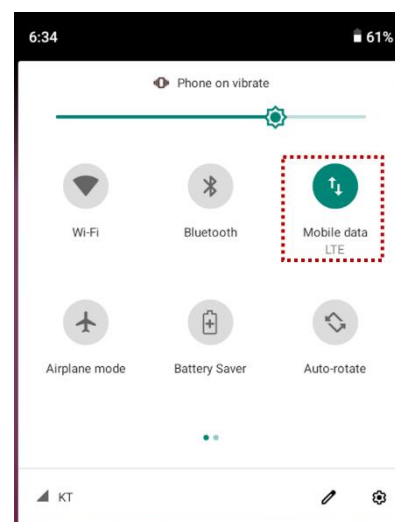

Figure 54 Mobile network icons on status bar



 **Note:** PM451 LTE SKU can connect to mobile network but can't do calling.

Wireless

Wi-Fi



1. Go to **Settings**  > **Network & internet**  > **Wi-Fi**
2. Tap toggle button to enable Wi-Fi
3. Device searches for nearby Wi-Fi signals and each SSID listed by signal strength
4. Select a Wi-Fi SSID you want to connect
5. The message **Connected** under the SSID means the device complete to connect to the Wi-Fi

Figure 55 Wi-Fi connected



Note: There are Open Wi-Fi network and Secured Wi-Fi network. You can tell those apart by lock icon () in the nearby Wi-Fi list. To connect the Secured Wi-Fi network, you need to enter the password.

Figure 56 Open Wi-Fi Network





Figure 57 Secured Wi-Fi Network



Wireless

Bluetooth

If you want to pair with a new device,

1. Go to **Settings**  > **Connected devices** 
2. Tap **Pair new device**
3. Select the desired device in **Available devices**
4. Check the pairing code in the dialog, tap **PAIR**

If you have the previously connected devices, the menu name as **Previously connected devices** will show up in **Connected devices**  (Figure 59)

Figure 58 Pair new device

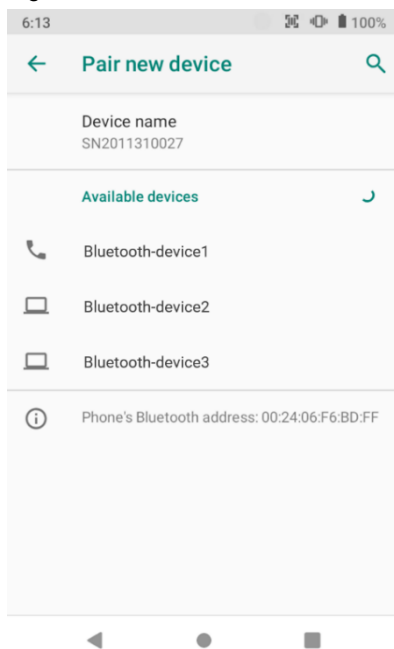
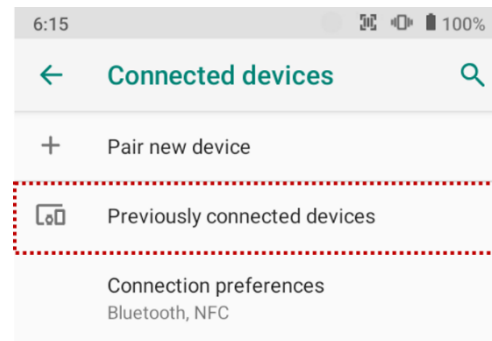

Figure 59 Previously connected devices



Wireless

NFC

PM451 supports NFC(Near Field Communication) feature. You can read information about the card and write texts for the card.

Referring to **Figure 60**, tag an NFC card to PM451

Figure 60 NFC tagging location

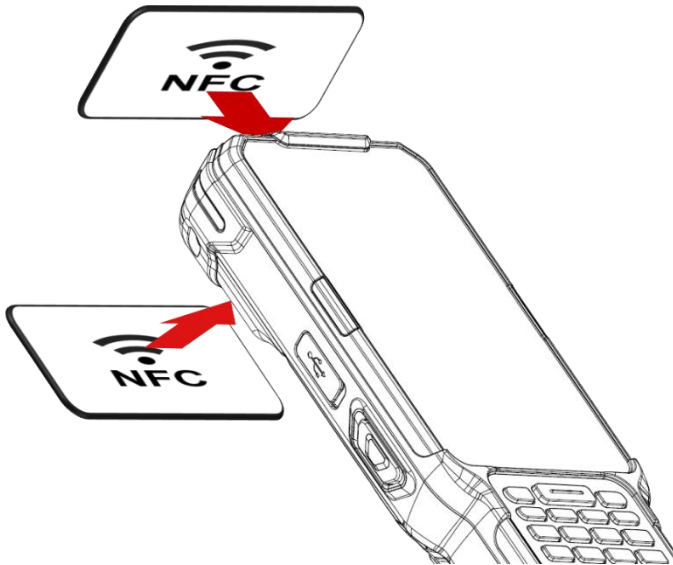



System Maintenance

System Information

There are two locations for checking system information.

On Settings

You can find the following information in **Settings**  > **About phone** ,

- Device name
- Legal information & Certificates
- Model & hardware
- IMEI & SIM status (LTE SKU only)
- Hostname
- Android version
- IP address
- Wi-Fi MAC address
- Bluetooth address
- Build number

On EmKit

You can find the following information in **EmKit**  > **System Information**,

- Processor information
- Version information (Android version, OS image version, SDK version, etc.)
- Manufacturer information (Serial number, Part Number, etc.)
- Device information (Camera, Audio, display, etc.)
- Battery information (Battery charging status, etc.)
- Application Version info (Version of Demos and Tools)

System Maintenance

OS Update

To improve the performance of your device, Point Mobile provides up-to-date OS(Operating System) version. You can update your device via storage, OTG port, and FOTA server. Depending on your workspace environment, choose one of the methods to update the OS.

i **Note:** Please backup your data before starting the update process.

OS Update via Storage

To update the OS using storage,



1. Download an OS image file into the root folder of microSD card or device internal storage
2. (In case of using SD card) Insert SD card to the device and then turn the device on
3. Go to **Settings**  > **System**  > **Advanced** > **System Update**
4. Check if the OS image file shows up in **AVAILABLE VERSIONS**

Figure 61 OS update via storage



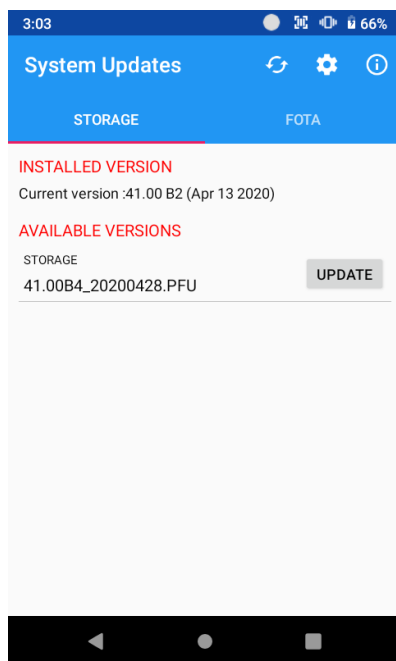

5. Tap **UPDATE** to start the update process

i **Note:** If the OS image file doesn't show up in **AVAILABLE VERSIONS**, check the file is placed in the root folder of storage. System only can recognize the file in the root folder.

System Maintenance

OS update from OTG Port

PM451 supports the USB OTG feature.

1. Prepare a formatted USB flash drive for OS update
2. Copy OS image file to the root folder of the flash drive
3. Connect the flash drive to the PM451
4. Go to **Settings**  > **System**  > **Advanced** > **System Update**
5. Check if the OS image file shows up in **AVAILABLE VERSIONS**
6. Tap **UPDATE** to start the update process

OS update via FOTA

If you can connect the network, you can use the FOTA server for the update.



1. Go to **Settings**  > **System**  > **Advanced** > **System Update**
2. Tap **FOTA** tab or Swipe left to move to **FOTA** tab. If there is an OS version newer than device's one, the server shows the new OS information

Figure 62 FOTA update tab



3. Tap **Download**

System Maintenance

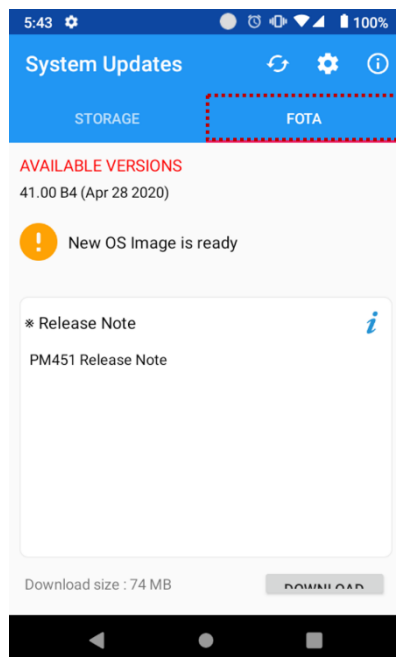
4. Tap **OK** on the **OS Update** dialog to start to download the OS image file

Figure 63 OS Update dialog

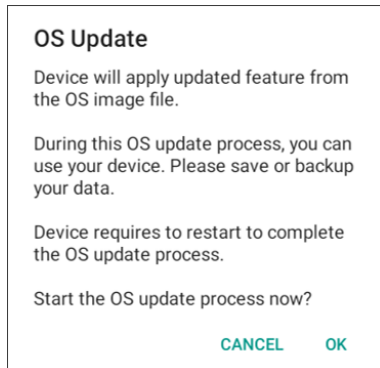

5. When completing the download, you may restart the device. Tap **OK** on the **Restart required** dialog to restart the device.

Figure 64 Restart required dialog

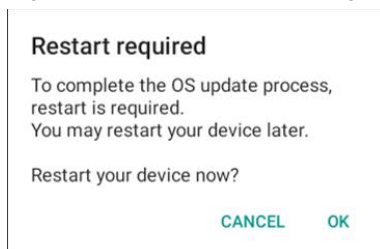

- i** **Note:** Basically, you can download OS image file over Wi-Fi or Ethernet only. If you want to download over Mobile Network too, change the setting value in FOTA Settings. Downloading over the Mobile network may result in additional charges.

Figure 65 FOTA Settings

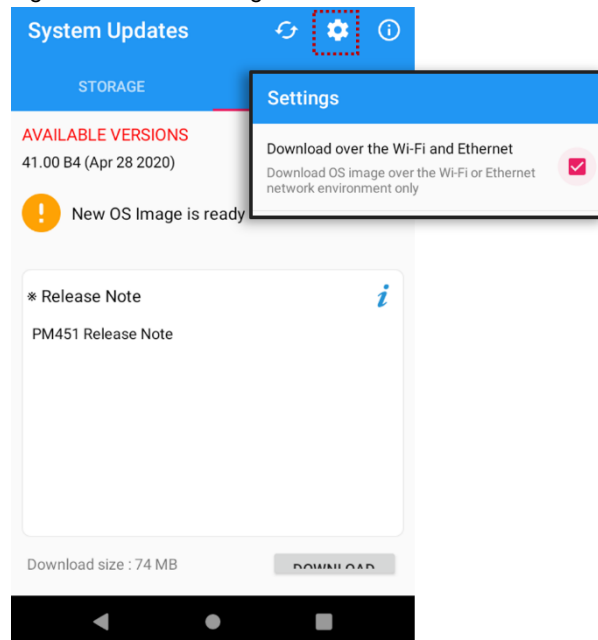

System Maintenance

Factory Data Reset



When you have a problem with your device or want to reset your device, follow the steps below to do a factory data reset.



Caution: *Factory data reset will erase all personalized settings and data saved in your phone, such as Google account, apps, user data, etc. And factory data reset cannot undo.*

Factory Data Reset via Settings app

If you can turn on the device and can access the Settings app,

1. Go to **Settings**  > **System**  > **Advanced** > **Reset options**
2. Tap **Erase all data (factory reset)**
3. After being aware that factory reset will erase all data from the internal storage, Tap **RESET**

PHONE

Figure 66 Factory reset screen

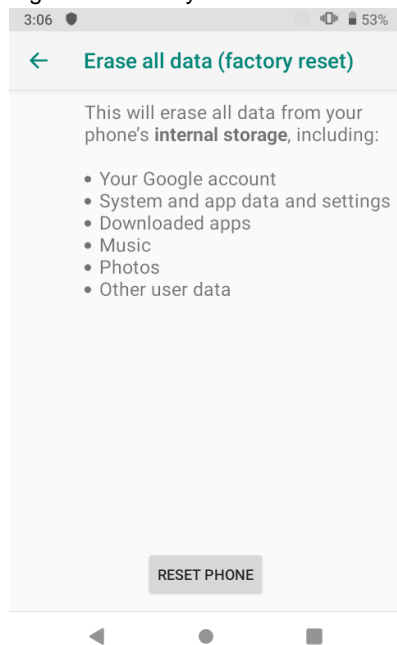

4. Tap **ERASE EVERYTHING** to start the factory reset process

System Maintenance

Factory Data Reset via Recovery mode

If you cannot turn on the device, try the following steps to do factory data reset using Android recovery mode.

1. Press and hold **SOFT_RIGHT** and **Fn** in the sequence of keys when PM451 turned off.

Figure 67 Recovery mode key combination

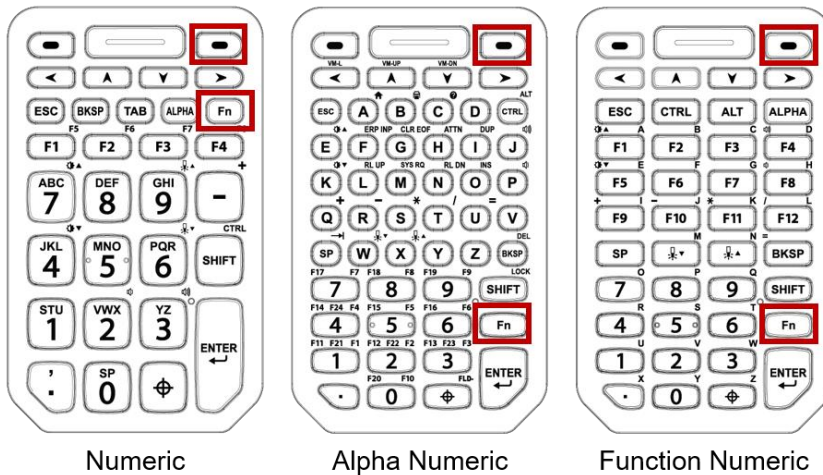

2. After short vibration, release the keys.
3. Using the keys below, select **Wipe data/factory reset**
 - **Move down** – any keys except Enter key and Power button
 - **Select the menu** – Enter key or Power button
4. After wiping the data, select **Reboot system now**

Figure 68 Factory reset via recovery mode

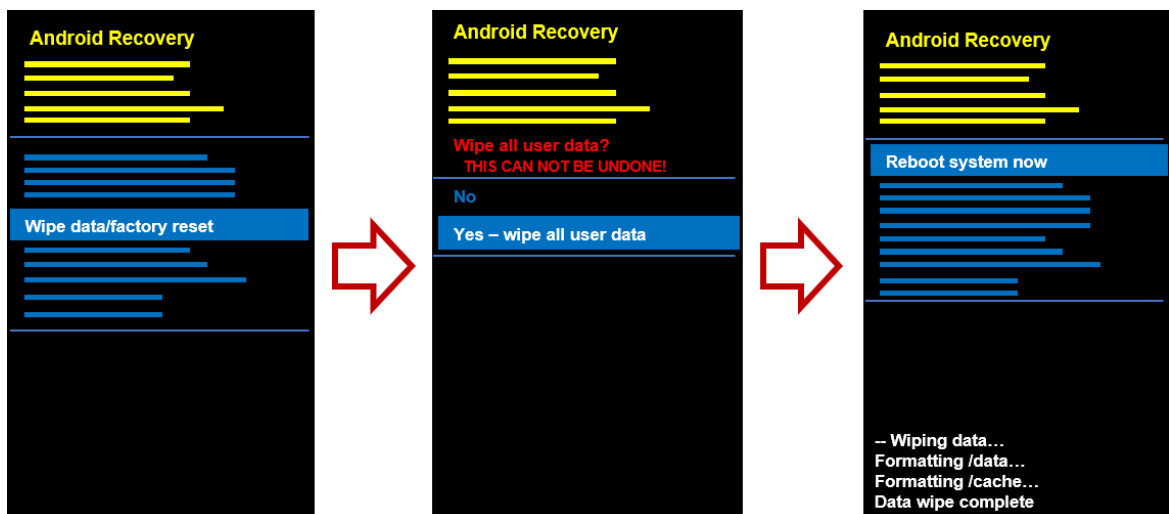

Gun Handle

Ergonomically designed gun handle is an optional accessory for PM451. You can grip the device comfortably, and scan a barcode with an easy-to-reach scan button.

Attach Gun Handle

1. Using a screwdriver, remove the four latch screws on the backside of PM451

Figure 69 Gun handle latch

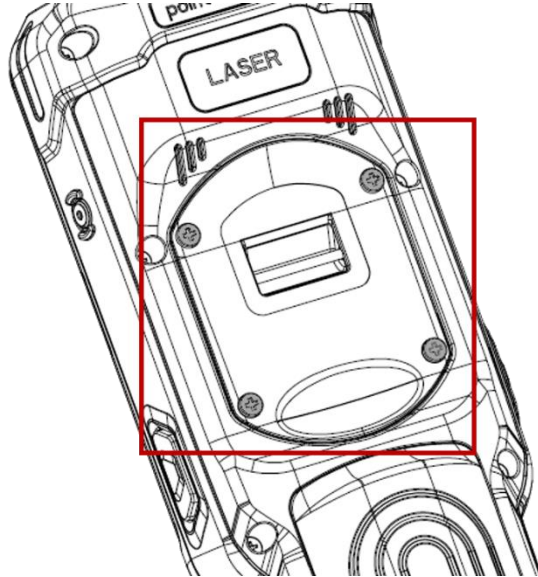

2. After remove the screws, open the gun handle connector cap

Figure 70 Open gun handle cap

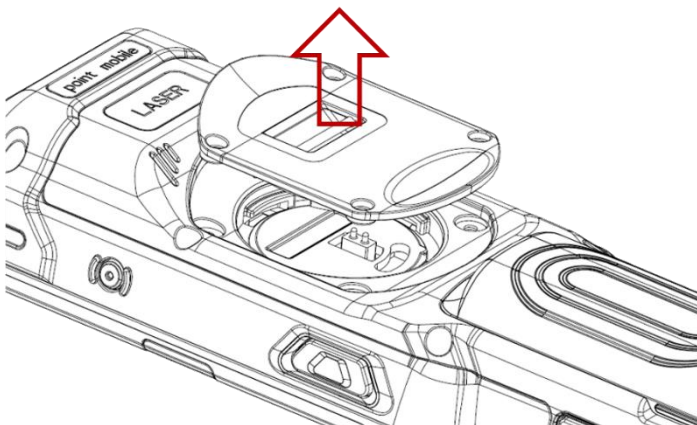

Gun Trigger

3. Attach a gun handle and lock the four screws using a screwdriver.

Figure 71 Gun handle installed

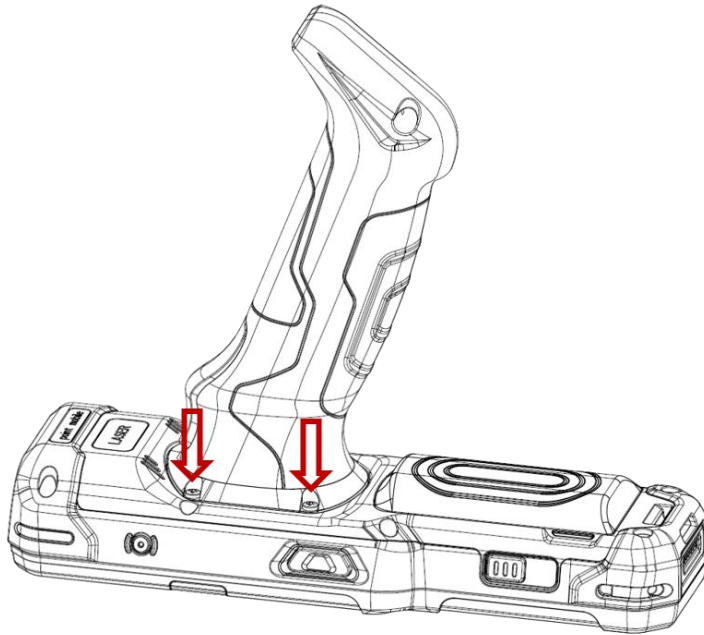

Note: You can scan a barcode by pressing the Scan button on the gun handle.

Figure 72 Gun handle - Scan button







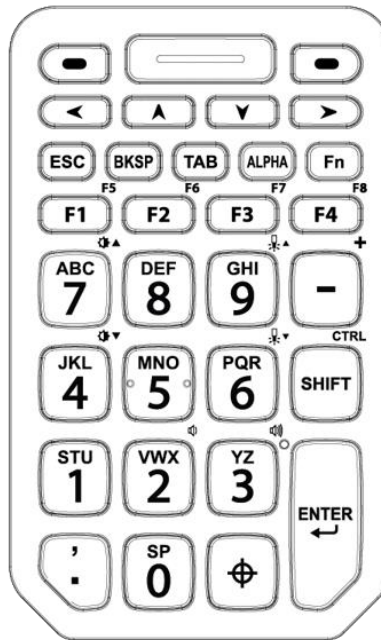

Using the Keypad











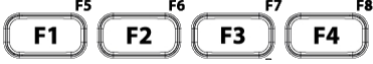

Numeric Keypad

Figure 73 Numeric keypad







Key	Description
P1 / P2 	Programmable keys, <ul style="list-style-type: none"> P1 is the PTT key by default. P2 is the Scan key by default.
Scan(Orange) 	Scan the barcode
Left / Up / Down / Right 	Moves left / up / down / right
ESC 	Escape function
Backspace 	Backspace function
Tab 	Tap function

Using the Keypad

Key	Description
Alpha (Yellow) 	Press once <ul style="list-style-type: none"> - Activate Alphabet input mode (Shown on the keypad in Yellow). The  icon appears on status bar Press twice <ul style="list-style-type: none"> - Back to default input mode
Fn (blue) 	Press once <ul style="list-style-type: none"> - Activate Functions input mode (Shown on the keypad in Blue). The  icon appears on status bar Press twice <ul style="list-style-type: none"> - Lock the Functions input mode. The  icon appears on status bar Press three times <ul style="list-style-type: none"> - Back to default input mode
Function 1~4(4~8) 	Function keys F1 to 4 (or F4 to 8 in Functions input mode)
Numeric 0~9 	The numeric keys 0 to 9. (or Alphabet keys in Alphabet input mode)
Minus 	Minus or hyphen key (or Plus key in Functions input mode)
Shift 	Press once <ul style="list-style-type: none"> - Activate Shift combination input mode. The  icon appears on status bar. Ex)  Press twice <ul style="list-style-type: none"> - Lock the Shift combination input mode. The  icon appears on status bar. Ex)  Press three times <ul style="list-style-type: none"> - Back to default input mode
Enter 	Enter function

Using the Keypad





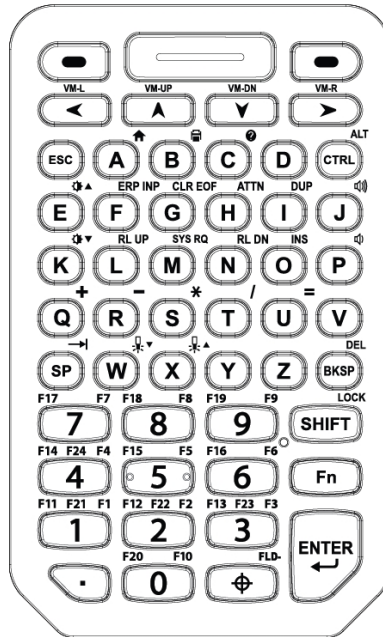

Key	Description												
Period / Decimal Point 	Input a period or a decimal point (or input comma in Alphabet input mode)												
Symbols 	Press once <ul style="list-style-type: none"> - Input a symbol you set. By default, '~' will be inserted. Press twice <ul style="list-style-type: none"> - Provides a 3x3 grid on the screen with nine additional symbols. Choose a symbol you want. <table border="1" data-bbox="678 632 976 877"> <tbody> <tr> <td></td> <td>@</td> <td>-</td> </tr> <tr> <td>~ <small>\u007e</small></td> <td><small>\u0040</small></td> <td><small>\u002d</small></td> </tr> <tr> <td>£ <small>\u00a3</small></td> <td>:</td> <td>€ <small>\u20ac</small></td> </tr> <tr> <td><small>\u007c</small></td> <td>[<small>\u005b</small></td> <td>] <small>\u005d</small></td> </tr> </tbody> </table> <ul style="list-style-type: none"> - You can change the configuration of the grid with Program buttons. Please refer to Program buttons. Press three times <ul style="list-style-type: none"> - Hide the grid 		@	-	~ <small>\u007e</small>	<small>\u0040</small>	<small>\u002d</small>	£ <small>\u00a3</small>	:	€ <small>\u20ac</small>	<small>\u007c</small>	[<small>\u005b</small>] <small>\u005d</small>
	@	-											
~ <small>\u007e</small>	<small>\u0040</small>	<small>\u002d</small>											
£ <small>\u00a3</small>	:	€ <small>\u20ac</small>											
<small>\u007c</small>	[<small>\u005b</small>] <small>\u005d</small>											

Using the Keypad













Alpha/Numeric Keypad

Figure 74 Alpha Numeric Keypad







Key	Description
P1 / P2 	Programmable keys, <ul style="list-style-type: none"> • P1 is the PTT key by default. • P2 is the Scan key by default.
Scan (Orange) 	Scan the barcode
Left / Up / Down / Right 	Moves left / up / down / right
ESC 	Escape function
Alpha Keys 	The Alphabet keys A to Z
Control (Green) 	Activate the CTRL functions mode. The  icon appears on the status bar. (or activate the ALT functions mode in Functions input mode)

Using the Keypad

Key	Description
Space 	Space function
Backspace 	Backspace function
Numeric 	The numeric keys 0 to 9. (or Function keys F1 to F23 with Fn / SHIFT / CTRL keys)
SHIFT (Yellow) 	<p>Press once</p> <ul style="list-style-type: none"> - Activate Shift combination input mode. The  icon appears on status bar. Ex)  <p>Press twice</p> <ul style="list-style-type: none"> - Lock the Shift combination input mode. The  icon appears on status bar. Ex)  <p>Press three times</p> <ul style="list-style-type: none"> - Back to default input mode
Fn (Blue) 	<p>Press once</p> <ul style="list-style-type: none"> - Activate Functions input mode (Shown on the keypad in Blue). The  icon appears on status bar <p>Press twice</p> <ul style="list-style-type: none"> - Lock the Functions input mode. The  icon appears on status bar <p>Press three times</p> <ul style="list-style-type: none"> - Back to default input mode
Enter 	Enter function
Period / Decimal Point 	Input a period or a decimal point

Using the Keypad

Key	Description									
Symbols 	<p>Press once</p> <ul style="list-style-type: none"> - Input a symbol you set. By default, '~' will be inserted <p>Press twice</p> <ul style="list-style-type: none"> - Provides a 3x3 grid on the screen with nine additional symbols. Choose a symbol you want. <table border="1" data-bbox="678 468 976 716"> <tbody> <tr> <td> ~ <small>\u007e</small></td> <td>@ <small>\u0040</small></td> <td>- <small>\u002d</small></td> </tr> <tr> <td>£ <small>\u00a3</small></td> <td>: <small>\u003a</small></td> <td>€ <small>\u20ac</small></td> </tr> <tr> <td> <small>\u007c</small></td> <td>[<small>\u005b</small></td> <td>] <small>\u005d</small></td> </tr> </tbody> </table> <ul style="list-style-type: none"> - You can change the configuration of the grid with Program buttons. Please refer to Program buttons. <p>Press three times</p> <ul style="list-style-type: none"> - Hide the grid 	 ~ <small>\u007e</small>	@ <small>\u0040</small>	- <small>\u002d</small>	£ <small>\u00a3</small>	: <small>\u003a</small>	€ <small>\u20ac</small>	 <small>\u007c</small>	[<small>\u005b</small>] <small>\u005d</small>
 ~ <small>\u007e</small>	@ <small>\u0040</small>	- <small>\u002d</small>								
£ <small>\u00a3</small>	: <small>\u003a</small>	€ <small>\u20ac</small>								
 <small>\u007c</small>	[<small>\u005b</small>] <small>\u005d</small>								



Note: The 5250 terminal emulation keypad configuration is only used when the 5250 emulation software runs on PM451.







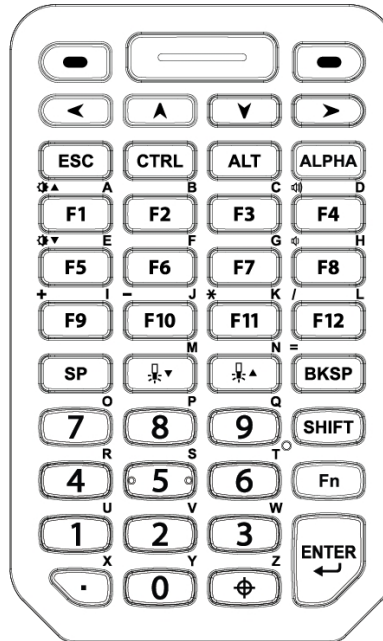

Ex) ERP INP, CLR EOF, SYS RQ keys in CTRL functions mode

Using the Keypad













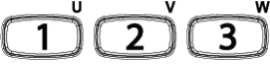

Function/Numeric Keypad

Figure 75 Function Numeric Keypad



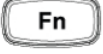



Key	Description
P1 / P2 	Programmable keys, <ul style="list-style-type: none"> P1 is the PTT key by default. P2 is the Scan key by default.
Scan (Orange) 	Scan the barcode
Left / Up / Down / Right 	Moves left / up / down / right
ESC 	Escape function
CTRL 	Activate the CTRL functions mode. The  icon appears on the status bar.
ALT 	Activate the ALT functions mode. The  icon appears on the status bar.

Using the Keypad







Key	Description
Alpha (Yellow) 	Press once <ul style="list-style-type: none"> - Activate Alphabet input mode (Shown on the keypad in Yellow). The  icon appears on status bar Press twice <ul style="list-style-type: none"> - Back to default input mode
Function 	Function keys F1 to 12 (or alphabet keys in Alphabet input mode)
Space 	Space function
Backspace 	Backspace function
Numeric 	Numeric keys 0 to 9 (or alphabet keys in Alphabet input mode)
Shift 	Press once <ul style="list-style-type: none"> - Activate the Shift input mode (Convert between the uppercase and lowercase). The  icon appears on status bar. Ex)  Press twice <ul style="list-style-type: none"> - Lock the Shift input mode. The  icon appears on status bar. Ex)  Press three times <ul style="list-style-type: none"> - Back to default input mode
Fn (Blue) 	Press once <ul style="list-style-type: none"> - Activate Functions input mode (Shown on the keypad in Blue). The  icon appears on status bar Press twice <ul style="list-style-type: none"> - Lock the Functions input mode. The  icon appears on status bar Press three times <ul style="list-style-type: none"> - Back to default input mode
Enter 	Enter function

Using the Keypad

Key	Description									
Period / Decimal Point 	Input a period or a decimal point (or alphabet Z key in Alphabet input mode)									
Symbols 	Press once <ul style="list-style-type: none"> - Input a symbol you set. By default, '~' will be inserted Press twice <ul style="list-style-type: none"> - Provides a 3x3 grid on the screen with nine additional symbols. Choose a symbol you want. <table border="1" data-bbox="678 577 976 825"> <tbody> <tr> <td> ~ \u007e</td> <td>@ \u0040</td> <td>- \u002d</td> </tr> <tr> <td>£ \u00a3</td> <td>: \u003a</td> <td>€ \u20ac</td> </tr> <tr> <td> \u007c</td> <td>[\u005b</td> <td>] \u005d</td> </tr> </tbody> </table> <ul style="list-style-type: none"> - You can change the configuration of the grid with Program buttons. Please refer to Program buttons. Press three times <ul style="list-style-type: none"> - Hide the grid 	 ~ \u007e	@ \u0040	- \u002d	£ \u00a3	: \u003a	€ \u20ac	 \u007c	[\u005b] \u005d
 ~ \u007e	@ \u0040	- \u002d								
£ \u00a3	: \u003a	€ \u20ac								
 \u007c	[\u005b] \u005d								

Using the Keypad

Functions

Key	Function	Numeric	Alpha-Numeric	Function-Numeric
	Volume down	Fn + 2	Fn + P	Fn + F8
	Volume up	Fn + 3	Fn + J	Fn + F4
	Display brightness down	Fn + 4	Fn + K	Fn + F5
	Display brightness up	Fn + 7	Fn + E	Fn + F1
	Keyboard backlight brightness down	Fn + 6	Fn + W	Keyboard Backlight Down
	Keyboard backlight brightness up	Fn + 9	Fn + X	Keyboard Backlight Up
CTRL	CTRL input mode	Fn + SHIFT	CTRL	CTRL
ALT	ALT input mode	-	Fn + CTRL	ALT
	Home	-	CTRL + A	-
	Screen Capture	Power + Move down		

Using the Keypad

Program Buttons

Point Mobile provides a solution that allows keys to be mapped to other functions or applications. To use the solution,

1. Go to **EmKit**  > **Program Buttons**
2. Select a key that you want to remap
3. Select a desired function or application in the list
4. Tap **OK**
5. After changing all key mapping, tap **Apply** to save the changes

Figure 76 Program Buttons_Properties



You can set the grid configuration of Symbols key in keypad with Program Buttons, too. To set the grid,

1. Move to **ADVANCED** tab
2. Tap a cell of the grid you want to change
3. Input the keycode of the desired symbol in the dialog
4. Tap **OK** on the dialog
5. After changing the configuration of grid, tap **Apply** to save the changes

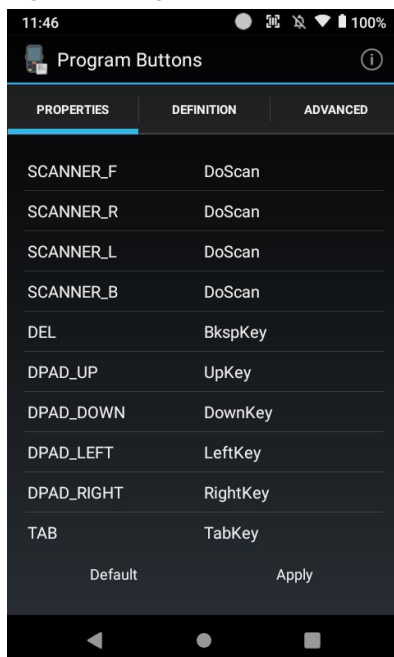
Using the Keypad

Figure 77 Program Buttons_Advanced

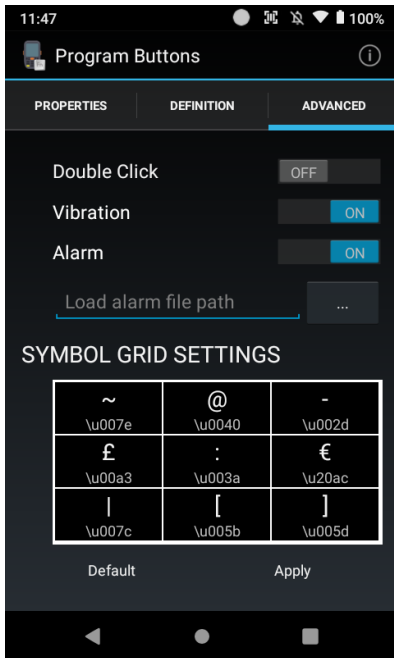

Microphone

Find the location of microphone by keypad type in **Figure 78**.

Figure 78 Location of microphone

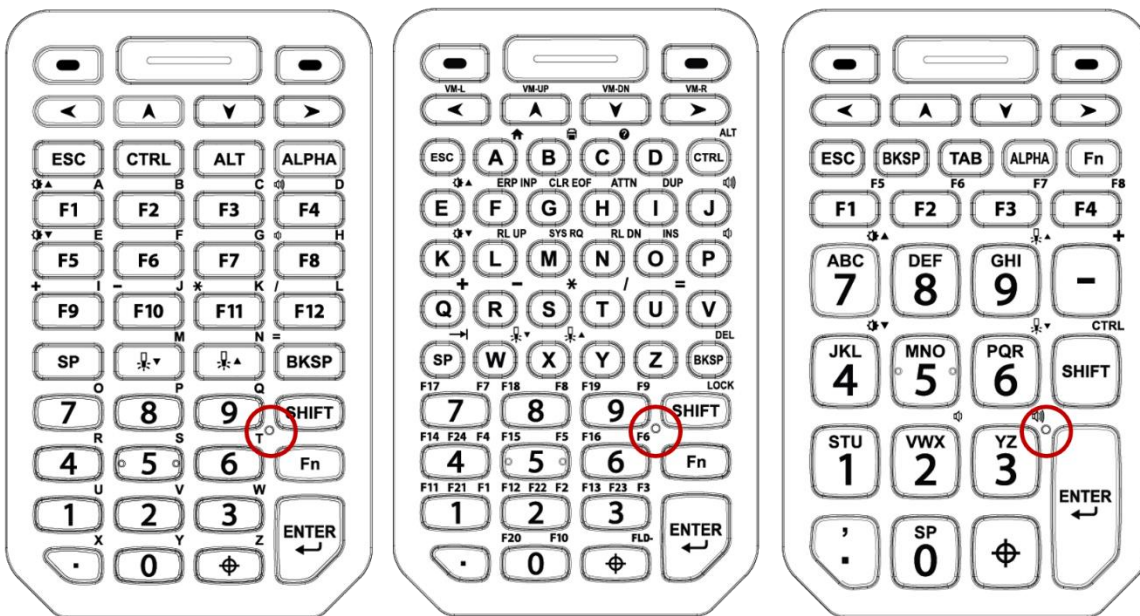

Safety Information

Please note PM451 is battery-embedded design with a removable battery. Unauthorized personnel are strictly prohibited from disassembling the device.

In case your device does not work as expected, you are strongly recommended to restart it by pressing and holding the power button for at least 12 seconds until the startup screen appears. If your phone has encountered a serious error and cannot be recovered, you should reset your phone to factory settings. For more details, please refer to [Factory Data Reset](#).



Caution: *Factory data reset will erase all personalized settings and data saved in your phone, such as Google account, apps, user data, etc. And factory data reset cannot undo.*

Battery Safety Information

Follow the battery safety guidelines for safe usage, storage, and disposal of Li-ion batteries. Improper battery use may result in a fire, explosion, or other critical hazards.

Battery Safety Guidelines

- Use only Point Mobile approved batteries and charging accessories. Other batteries and chargers may damage the device or result in a fire, leakage, or other hazards.
- Do not expose the battery to excessive heat or cold.
- Do not use or store the battery in or near areas that might get very hot, such as in a parked vehicle, near a heat duct or close to other heat sources.
- Do not allow objects that may cause a short circuit, such as metal objects, corrosive substances, or liquids like water, to contact the battery.
- Do not disassemble, crush, bend, shred, press, or other actions that may damage or deform the battery.
- Do not use or replace the battery on the go or from a high location. Dropping may result in an explosion or fire.
- Do not put any labels, stickers, tags, etc. on the device or battery. Performance of the device or battery, such as sealing, drop, or tumble, could be affected.
- Close supervision is necessary when used near children to avoid the risk of injury.
- If battery leakage is observed, avoid any contact with the skin or eyes and properly dispose of the battery. If contact has been made, wash the affected area with water for 15 minutes and seek medical advice.
- If you notice any type of damage to the battery, such as swelling, dents, and leaks, stop using it immediately and contact Point Mobile.

Safety Information

Battery Charging Guidelines

- Charge the battery in a clean, cool, dry, and ventilated environment.
- Separate the charger from the battery as soon as possible when the battery is fully charged.
- Battery performance can degrade due to the stress of daily charging and discharging. Batteries typically need to be replaced after 300 to 500 charging cycles (full charge-discharge cycles) or when the battery capacity has been reduced to 70 ~ 80% of its original capacity. The actual number of charging cycles varies based on usage patterns, temperature, age, and other factors.

Battery Storage / Disposal Guidelines

- Store the batteries in a clean, dry and ventilated environment within ambient temperature ranges of $20\pm 5^{\circ}\text{C}$.
- For safety regulations, batteries are charged to below 20~30% of full capacity during production.
- When not using batteries for a long period, charge the battery for 30 minutes to 1 hour at least once every 6 months to prevent full discharge and keep the performance.
- Batteries should be stored separately when storing for long periods. Disconnect from any device, charger, or cradle.
- Dispose of used batteries promptly according to local disposal regulations.
- Do not dispose of the battery in fire. It may cause explosion.



Notice: The battery is consumable. Point Mobile provides a warranty for the battery for 12 months after purchase.

If you suspect the battery swelling, change the battery immediately and contact Point Mobile.



Point Mobile. Co., Ltd.

Offline

Tel: +82-2-3397-7870~1

ARS: +82-1800-3010

Fax: +82-2-3397-7872

Address: 9F Kabul Great Valley, 32, Digital-ro 9-gil,
Geumcheon-gu, Seoul, Korea 08512

Online

Website: <https://www.pointmobile.com>

E-mail: pm_support@pointmobile.com